

 HEMCO

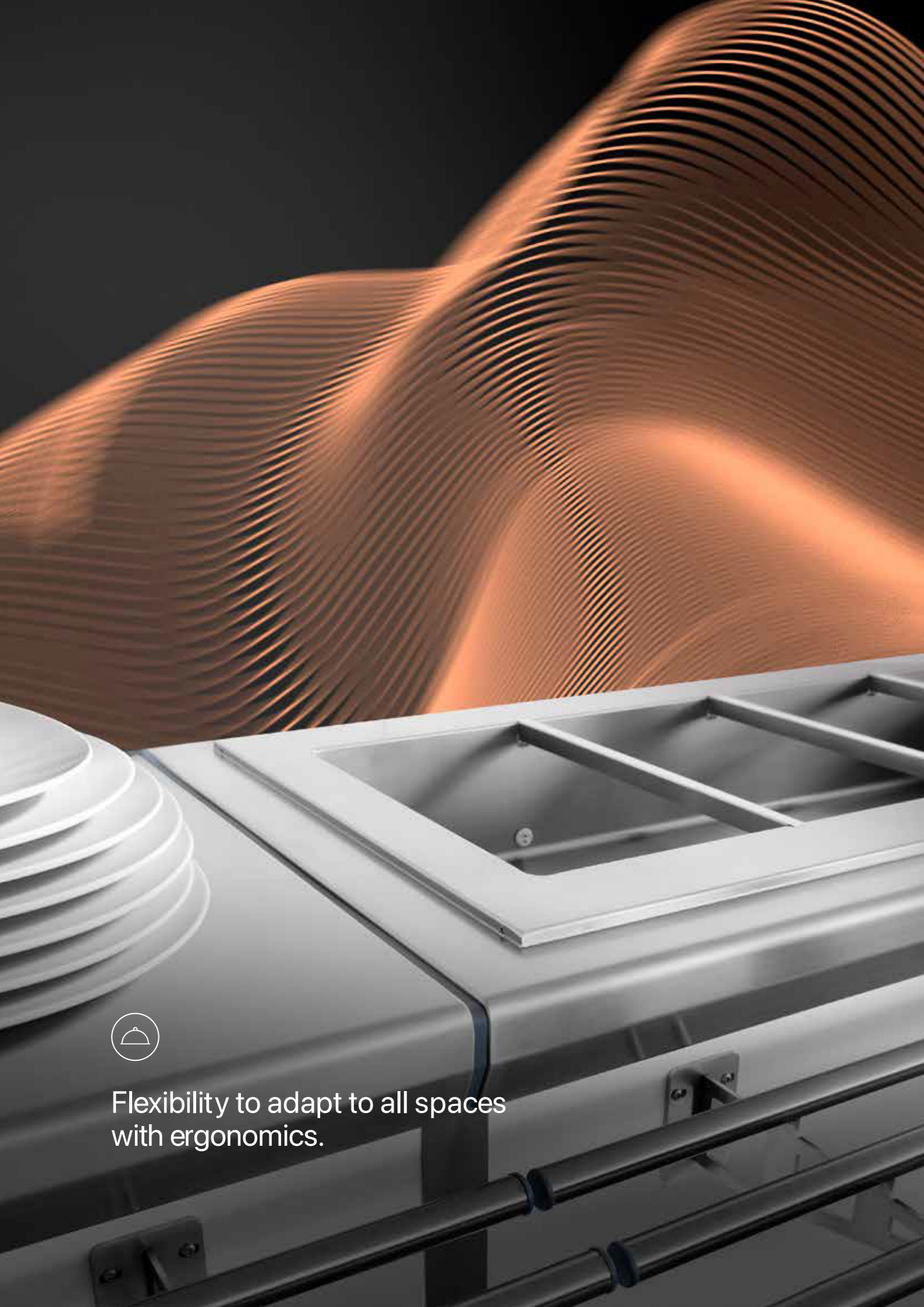

EU-EN 2025



Flexibility to adapt to all spaces
with ergonomics.

Self Service



Self Suite	397
—	399
—	401
—	403
—	405
—	407
—	408
Foodshield with shelf and protection frontal glass	409
Foodshields and Glasses	409
Accessories	410
Configuration options	412

- Front panels in water-resistant medium density fibreboard



satin finish.





TRAY DISPENSER

	SS-77	18001483	798x780x400	2 Columns	160	-	-	-	-	-
	SS-147	18001484	1450x780x400	4 Columns	320	-	-	-	-	-



TRAY AND CUTLERY DISPENSER OVER A BASE

	D-R-313	18003180	798x780x1514	3 GN 1/3 -150mm	160	150	-	-	Rectangular	-
	D-R-613	18003190	1450x780x1514	6 GN 1/3 -150mm	320	300	-	-	Rectangular	-

TRAY, CUTLERY AND BREAD DISPENSER OVER A BASE

	D-R-313/2	18003191	798x780x1514	3 GN 1/3 - 150mm + 1 GN 2/1- 200mm	160	150	120	-	Rectangular	-
	D-R-613/2	18003192	1450x780x1514	6 GN 1/3 - 150mm + 2 GN 2/1- 200mm	320	300	240	-	Rectangular	-



GLASS DISPENSER OVER A BASE

	DV-R-6	18003193	798x780x1569	6 glass levels	-	-	-	324/360	Rectangular	-
	DV-R-62	18003196	1450x780x1569	2x6 glass levels	-	-	-	648/720	Rectangular	-



TRAY, CUTLERY, BREAD AND GLASS DISPENSER OVER A BASE

	DVCP-R-6	18003199	1450x780x1569	3 GN 1/3 - 150 mm + 1 GN 2/1 - 200 mm + 6 glass levels	160	150	120	324/360	Rectangular	-
---	----------	----------	---------------	--	-----	-----	-----	---------	-------------	---

CUTLERY DISPENSER OVER NEUTRAL ELEMENT

	DC-R-1	19071811	696x345x536	3 GN 1/3 - 150 mm	150	-	-	Rectangular	-
	DC-R-2	19071812	696x345x658	6 GN 1/3 - 150 mm	300	-	-	Rectangular	-

BREAD DISPENSER OVER NEUTRAL ELEMENT

	DP-R-1	19071813	696x667x600	1 GN 2/1 - 200 mm	-	120	-	Rectangular	-
	DP-R-2	19071814	696x667x725	2 GN 2/1 - 200 mm	-	240	-	Rectangular	-

CUTLERY AND BREAD DISPENSER OVER NEUTRAL ELEMENT

	DCP-R	19071815	696x667x658	3 GN 1/3 - 150 mm + 1 GN 2/1 - 200 mm	150	120	-	Rectangular	-
---	-------	----------	-------------	---------------------------------------	-----	-----	---	-------------	---

GLASS DISPENSER OVER NEUTRAL ELEMENT



	DV-R-4 SB	19071816	696x745x829	4 glass levels	-	-	216/240	Rectangular	-
---	-----------	----------	-------------	----------------	---	---	---------	-------------	---

satin finish.





- Front panels in water-resistant medium density fibreboard (MDF).



NEUTRAL ELEMENT





	SM-450	18001494	450x850x900	Closed without neutral reserve	-	-
	SM-2	18001495	950x850x900	Open / neutral reserve	2	-
	SM-3	18001496	1375x850x900	Open / neutral reserve	3	-
	SM-4	18001497	1600x850x900	Open / neutral reserve	4	-
	SM-5	18001498	1985x850x900	Open / neutral reserve	5	-
	SM-6	18001499	2335x850x900	Open / neutral reserve	6	-
	SM-3-P	18001500	1375x850x900	Neutral reserve with 2 sliding doors and 1 optional intermediate shelf	3	-
	SM-4-P	18001501	1600x850x900	Neutral reserve with 2 sliding doors and 1 optional intermediate shelf	4	-
	SM-5-P	18001502	1985x850x900	Neutral reserve with 2 sliding doors and 1 optional intermediate shelf	5	-
	SM-6-P	18001503	2335x850x900	Neutral reserve with 2 sliding doors and 1 optional intermediate shelf	6	-

CORNER ELEMENT

	SA-I-90	18001504	1141x1141x900	90° internal angle. Open / neutral reserve	-	-
	SA-I-45	18001505	850x850x900	45° internal angle. Open / neutral reserve	-	-
	SA-E-90	18001506	935x935x900	90° external angle. Without neutral reserve	-	-
	SA-E-45	18001507	850x850x900	45° external angle. Without neutral reserve	-	-



CASH REGISTER ELEMENT

	SMC-12-D	18001514	1375x850x900	Cash register element with side arm to the right	-
	SMC-12-I	18001516	1375x850x900	Cash register element with side arm to the left	-
	SMC-6-D	18001519	605x850x900	Cash register element without side arm (cash register to the right)	-
	SMC-6-I	18001520	605x850x900	Cash register element without side arm (cash register to the left)	-
	SMC-8-F	18001521	800x850x900	Cash register element without side arm (cash register facing public)	-

FACADE ELEMENT





	F-5	18001720	550x215x900	Facade element= 550 mm	-
---	-----	----------	-------------	------------------------	---

PLATE DISPENSER

	DAN-95	18001508	950x850x900	2 plate columns - neutral	80-90	-	45 per column	-	-
	DAC-95	18001509	950x850x900	2 plate columns - heated	80-90	-	45 per column	960	-

GLASS BASKET DISPENSER



	DPAN-95	18001510	950x850x900	5/6 glass baskets	-	200 // 265	120	-	-
---	---------	----------	-------------	-------------------	---	------------	-----	---	---

satin finish.

- Front panels in water-resistant medium density fibreboard (MDF).





STATIC REFRIGERATED PLATE ELEMENT

	DSCSP-SR-3	R290	50/60	18007711	1375x850x900	-	3	Open / neutral reserve	215	4	-
	DSCSP-SR-4	R290	50/60	18007712	1600x850x900	-	4	Open / neutral reserve	225	4	-
	DSCSP-SR-5	R290	50/60	18007713	1985x850x900	-	5	Open / neutral reserve	305	4	-
	DSCSP-SR-6	R290	50/60	18007714	2335x850x900	-	6	Open / neutral reserve	330	4	-
	DSCSP-CR-3	R290	50/60	18007715	1375x850x900	-	3	1 x GN2/1 refrigerated reserve	380	4	-
	DSCSP-CR-4	R290	50/60	18007716	1600x850x900	-	4	1 x GN2/1 refrigerated reserve	390	4	-
	DSCSP-CR-5	R290	50/60	18007717	1985x850x900	-	5	2 x GN2/1 refrigerated reserve	575	4	-
	DSCSP-CR-6	R290	50/60	18007718	2335x850x900	-	6	2 x GN2/1 refrigerated reserve	600	4	-



VENTILATED REFRIGERATED WELL ELEMENT

	FSCV-SR-3	R290	50/60	18004636	1375x850x900	35- 82-120	3	Open / neutral reserve	375	4	Included	-
	FSCV-SR-4	R290	50/60	18004637	1600x850x900	35- 82-120	4	Open / neutral reserve	380	4	Included	-
	FSCV-SR-5	R290	50	18004638	1985x850x900	35- 82-120	5	Open / neutral reserve	485	4	Included	-
	FSCV-SR-6	R290	50	18004639	2335x850x900	35- 82-120	6	Open / neutral reserve	510	4	Included	-
	FSCV-CR-3	R290	50/60	18004640	1375x850x900	35- 82-120	3	1 x GN2/1 refrigerated reserve	525	4	Included	-
	FSCV-CR-4	R290	50/60	18004641	1600x850x900	35- 82-120	4	1 x GN2/1 refrigerated reserve	530	4	Included	-
	FSCV-CR-5	R290	50	18004642	1985x850x900	35- 82-120	5	2 x GN2/1 refrigerated reserve	695	4	Included	-
	FSCV-CR-6	R290	50	18004643	2335x850x900	35- 82-120	6	2 x GN2/1 refrigerated reserve	720	4	Included	-

ISLAND-TYPE STATIC REFRIGERATED WELL ELEMENT

	FSCR-3	R290	50/60	18004684	1265x875x900	80	3	-	215	4	Included	-
	FSCR-4	R290	50/60	18004685	1590x875x900	80	4	-	225	4	Included	-
	FSCR-5	R290	50/60	18004686	1975x875x900	80	5	-	305	4	Included	-
	FSCR-6	R290	50/60	18004687	2325x875x900	80	6	-	330	4	Included	-

ISLAND-TYPE VENTILATED REFRIGERATED WELL ELEMENT

	FSCV-3	R290	50/60	18004688	1265x875x900	35- 82-120	3	-	375	4	Included	-
	FSCV-4	R290	50/60	18004689	1590x875x900	35- 82-120	4	-	380	4	Included	-
	FSCV-5	R290	50	18004690	1975x875x900	35- 82-120	5	-	485	4	Included	-
	FSCV-6	R290	50	18004691	2325x875x900	35- 82-120	6	-	510	4	Included	-

satin finish.

- Front panels in water-resistant medium density fibreboard



GLASS CERAMIC PLATE HOT ELEMENT

	SV-SR-2	230V 1N 50/60	18001658	950x850x900	2	Open / neutral reserve	905	-
	SV-SR-3	230V 1N 50/60	18001610	1375x850x900	3	Open / neutral reserve	1355	-
	SV-SR-4	230V 1N 50/60	18001611	1600x850x900	4	Open / neutral reserve	1805	-
	SV-SR-5	230V 1N 50/60	18001612	1985x850x900	5	Open / neutral reserve	2255	-
	SV-SR-6	230V 1N 50/60	18001613	2335x850x900	6	Open / neutral reserve	2710	-
	SV-CR-3	230V 1N 50/60	18001614	1375x850x900	3	Hot reserve	2805	-
	SV-CR-4	230V 1N 50/60	18001615	1600x850x900	4	Hot reserve	3255	-
	SV-CR-5	400V 3N 50/60	18001616	1985x850x900	5	Hot reserve	4275	-
	SV-CR-6	400V 3N 50/60	18001617	2335x850x900	6	Hot reserve	5710	-



WET BAIN MARIE HOT ELEMENT

	SBM-SR-2	230V 1N 50/60	18001618	950x850x900	190	2	Open / neutral reserve	1510	-
	SBM-SR-3	230V 1N 50/60	18001619	1375x850x900	190	3	Open / neutral reserve	2005	-
	SBM-SR-4	230V 1N 50/60	18001620	1600x850x900	190	4	Open / neutral reserve	2510	-
	SBM-SR-5	230V 1N 50/60	18001621	1985x850x900	190	5	Open / neutral reserve	3030	-
	SBM-SR-6	230V 1N 50/60	18001622	2335x850x900	190	6	Open / neutral reserve	3555	-
	SBM-CR-3	230V 1N 50/60	18001623	1375x850x900	190	3	Hot reserve	2905	-
	SBM-CR-4	230V 1N 50/60	18001624	1600x850x900	190	4	Hot reserve	3360	-
	SBM-CR-5	400V 3N 50/60	18001625	1985x850x900	190	5	Hot reserve	4480	-
	SBM-CR-6	400V 3N 50/60	18001626	2335x850x900	190	6	Hot reserve	5245	-

DRY BAIN MARIE HOT ELEMENT

	DSHV-SR-3	230V 1N 50/60	18007737	1375x850x900	234	3	Open / neutral reserve	1250	-
	DSHV-SR-4	230V 1N 50/60	18007738	1600x850x900	234	4	Open / neutral reserve	1250	-
	DSHV-SR-5	230V 1N 50/60	18007739	1985x850x900	234	5	Open / neutral reserve	2050	-
	DSHV-SR-6	230V 1N 50/60	18007741	2335x850x900	234	6	Open / neutral reserve	2050	-
	DSHV-CR-3	230V 1N 50/60	18007742	1375x850x900	234	3	Hot reserve	2100	-
	DSHV-CR-4	230V 1N 50/60	18007743	1600x850x900	234	4	Hot reserve	2100	-
	DSHV-CR-5	230V 1N 50/60	18007744	1985x850x900	234	5	Hot reserve	3500	-
	DSHV-CR-6	400V 3N 50/60	18007745	2335x850x900	234	6	Hot reserve	3740	-

ISLAND-TYPE GLASS CERAMIC PLATE HOT ELEMENT

	SV-3	230V 1N 50/60	18001643	1265x875x900	-	3	-	1355	-
	SV-4	230V 1N 50/60	18001644	1590x875x900	-	4	-	1805	-
	SV-5	230V 1N 50/60	18001645	1975x850x900	-	5	-	2255	-
	SV-6	230V 1N 50/60	18001646	2325x875x900	-	6	-	2710	-

satin finish.

- Front panels in water-resistant medium density fibreboard



TEXTILE CURTAIN (CT)

SERVICE SIDE: SWING DOORS (H)

DSRVC-H-SR-CT-3-3	R290	50	18007719	1375x850x1722	3	Open / Neutral reserve	Textile curtain	970	3M2	Included	-
DSRVC-H-SR-CT-3-4	R290	50	18007721	1600x850x1722	4	Open / Neutral reserve	Textile curtain	1200	3M2	Included	-
DSRVC-H-CR-CT-3-3	R290	50	18007724	1375x850x1722	3	1GN2/1 refrigerated reserve	Textile curtain	1120	3M2	Included	-
DSRVC-H-CR-CT-3-4	R290	50	18007725	1600x850x1722	4	1GN2/1 refrigerated reserve	Textile curtain	1350	3M2	Included	-

SERVICE SIDE: SLIDING DOORS (S)

DSRVC-S-SR-CT-3-3	R290	50	18007728	1375x850x1710	3	Open / Neutral reserve	Textile curtain	665	3M2	Included	-
DSRVC-S-SR-CT-3-4	R290	50	18007729	1600x850x1710	4	Open / Neutral reserve	Textile curtain	1200	3M2	Included	-
DSRVC-S-CR-CT-3-3	R290	50	18007732	1375x850x1710	3	1GN2/1 refrigerated reserve	Textile curtain	810	3M2	Included	-
DSRVC-S-CR-CT-3-4	R290	50	18007733	1600x850x1710	4	1GN2/1 refrigerated reserve	Textile curtain	1350	3M2	Included	-

CLAPETS (CP)

SERVICE SIDE: SWING DOORS (H)

DSRVC-H-SR-CP-3-3	R290	50	18007722	1375x850x1722	3	Open / Neutral reserve	Clapets	970	3M1	Included	-
DSRVC-H-SR-CP-3-4	R290	50	18007723	1600x850x1722	4	Open / Neutral reserve	Clapets	1200	3M1	Included	-
DSRVC-H-CR-CP-3-3	R290	50	18007726	1375x850x1722	3	1GN2/1 refrigerated reserve	Clapets	1120	3M1	Included	-
DSRVC-H-CR-CP-3-4	R290	50	18007727	1600x850x1722	4	1GN2/1 refrigerated reserve	Clapets	1350	3M1	Included	-

SERVICE SIDE: SLIDING DOORS (S)

DSRVC-S-SR-CP-3-3	R290	50	18007730	1375x850x1710	3	Open / Neutral reserve	Clapets	665	3M1	Included	-
DSRVC-S-SR-CP-3-4	R290	50	18007731	1600x850x1710	4	Open / Neutral reserve	Clapets	1200	3M1	Included	-
DSRVC-S-CR-CP-3-3	R290	50	18007734	1375x850x1710	3	1GN2/1 refrigerated reserve	Clapets	810	3M1	Included	-
DSRVC-S-CR-CP-3-4	R290	50	18007736	1600x850x1710	4	1GN2/1 refrigerated reserve	Clapets	1350	3M1	Included	-

satin finish.

- Front panels in water-resistant medium density fibreboard



CUBIC HOT GLASS CERAMIC DISPLAY

DSHVC-S-SR-3-3	400V 3N 50/60	18007746	1375x850x1717	3	Open / neutral reserve	Open	3620	-
DSHVC-S-SR-3-4	400V 3N 50/60	18007747	1600x850x1717	4	Open / neutral reserve	Open	4970	-
DSHVC-S-SR-3-5	400V 3N 50/60	18007748	1925x850x1717	5	Open / neutral reserve	Open	6320	-
DSHVC-S-CR-3-3	400V 3N 50/60	18007749	1375x850x1717	3	Hot reserve	Open	5070	-
DSHVC-S-CR-3-4	400V 3N 50/60	18007750	1600x850x1717	4	Hot reserve	Open	6420	-
DSHVC-S-CR-3-5	400V 3N 50/60	18007751	1925x850x1717	5	Hot reserve	Open	8790	-

Shower units

1200 mm height

- High-quality, durable and ergonomic shower unit. Designed for intensive use in professional kitchens.
- Polished chrome plated brass body, with steel spring hose and flexible tube with protective coating in transparent

- plastic resistant to high temperature and water pressure.
- Support column in AISI-304 18/10 stainless steel, for lasting protection against corrosion.
- Ergonomic shower with anti-heat plastic

- handle, flow regulation, with clip ring for continuous use and non-return valve.
- Connecting tubes and all needed accessories for installation included.

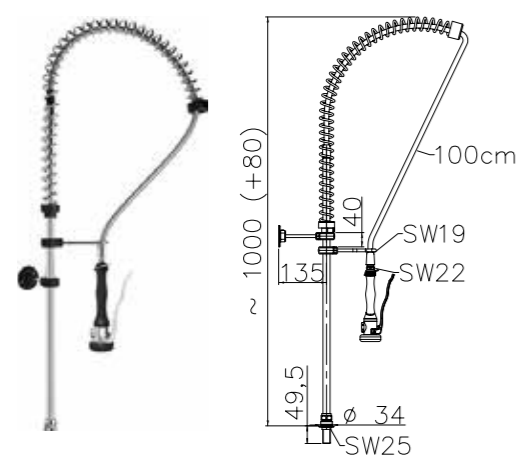

MODEL	CODE	DESCRIPTION	€
FPD-11	19095041	Direct water shower unit	-

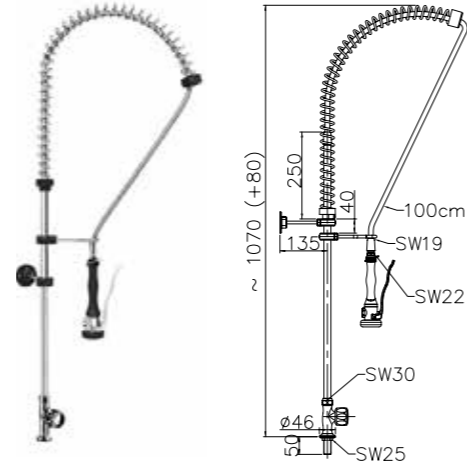

MODEL	CODE	DESCRIPTION	€
FPTH-11	19095042	One-hole connection shower unit	-

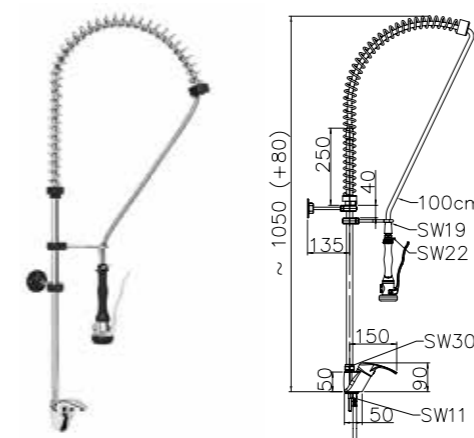

MODEL	CODE	DESCRIPTION	€
FPSL-21	19095045	Two-hole shower unit with single lever	-

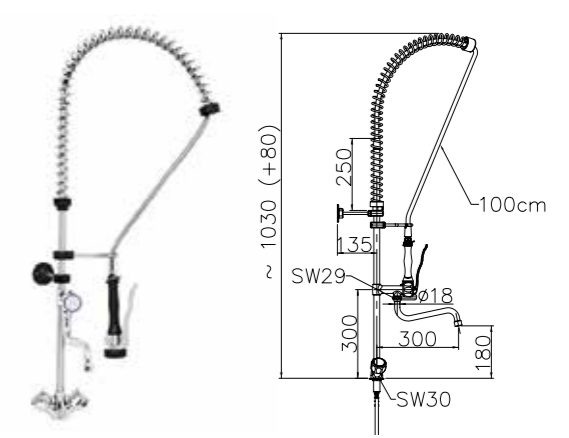

MODEL	CODE	DESCRIPTION	€
FPTH-21-MS	19095046	Two-hole shower unit with faucet	-

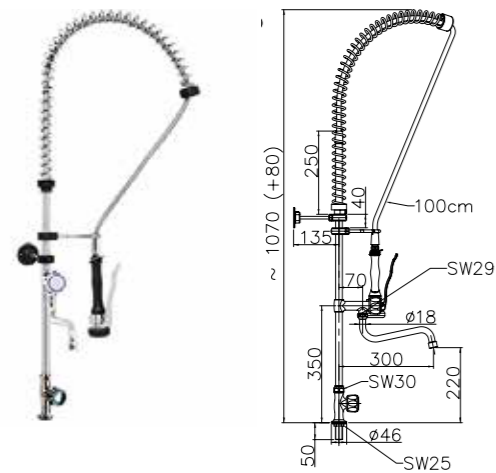

MODEL	CODE	DESCRIPTION	€
FPTH-11-MS	19095043	One-hole shower unit with faucet	-

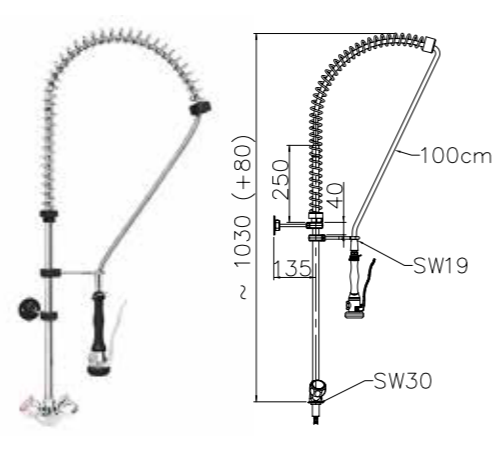

MODEL	CODE	DESCRIPTION	€
FPTH-21	19095044	Two-hole connection shower unit	-

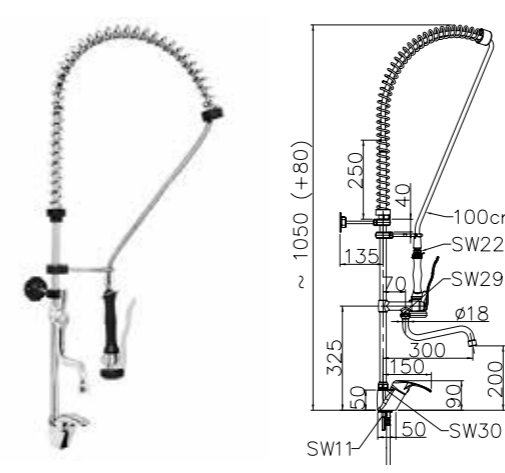

MODEL	CODE	DESCRIPTION	€
FPSL-21-MS	19095047	Two-hole shower unit with single lever and faucet	-

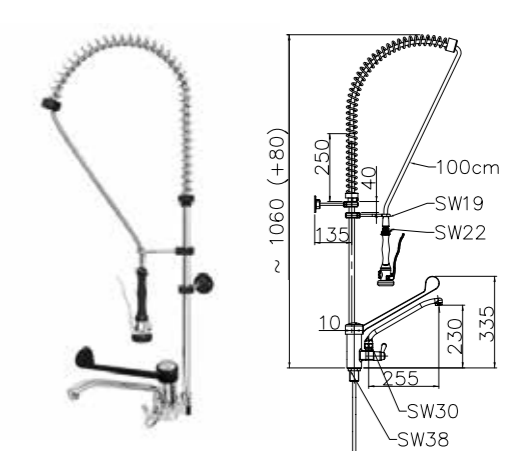

MODEL	CODE	DESCRIPTION	€
FPCL-21	19095048	Gerontological shower unit with faucet	-

1200 mm height

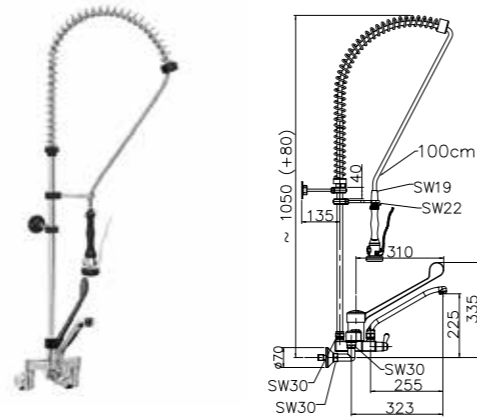
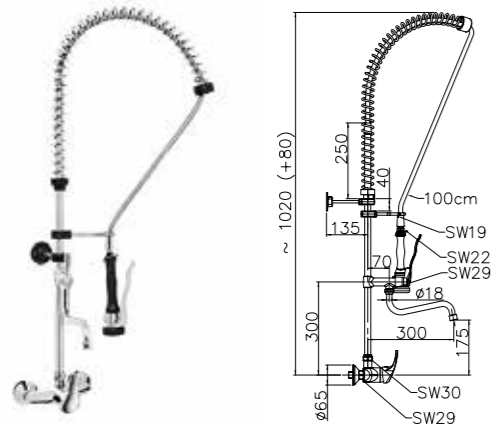

MODEL	CODE	DESCRIPTION	€
FPSL-22W-MS	19095049	Wall-mounted shower unit with faucet	-

MODEL	CODE	DESCRIPTION	€
FPCL-22W	19095060	Gerontological wall-mounted shower unit	-

600 mm height

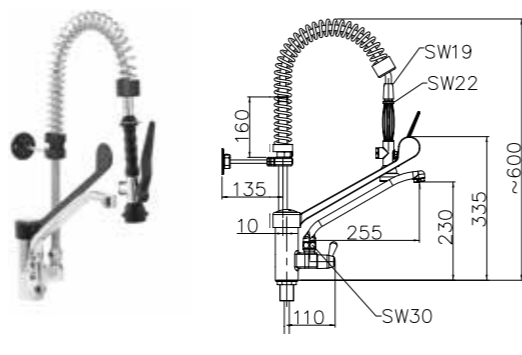
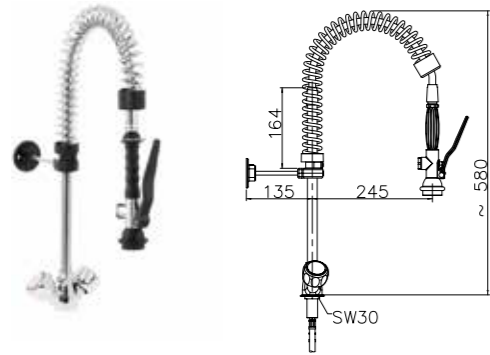

MODEL	CODE	DESCRIPTION	€
FP6TH-21	19095061	Two-hole shower unit height 600 mm	-

MODEL	CODE	DESCRIPTION	€
FP6CL-21	19095062	Two-hole gerontological shower unit height 600 mm	-

Manual faucets

- High-quality manual faucet. Designed for intensive use in professional kitchens.
- Polished chrome plated brass body.

- Handle ergonomic design makes easier water flow opening, regulating and closing operations.

- Connecting tubes and all needed accessories for installation included.

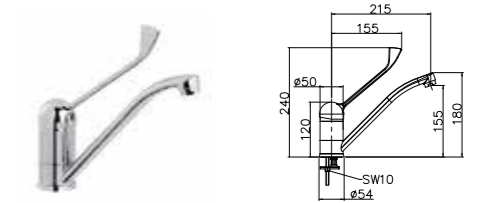
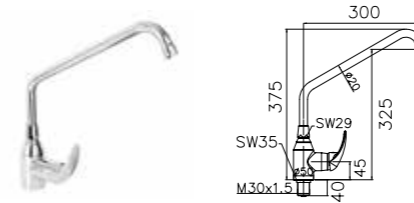

MODEL	CODE	DESCRIPTION	€
FMSL-123	19095063	Single lever mixer faucet with high swivel nozzle	-

MODEL	CODE	DESCRIPTION	€
FMCL-112	19095064	High single lever mixer faucet with low swivel nozzle	-

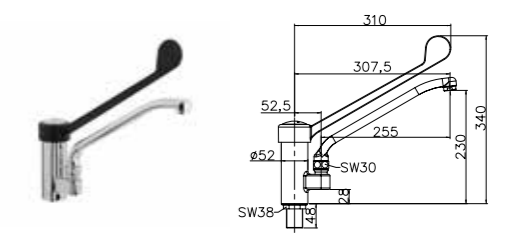
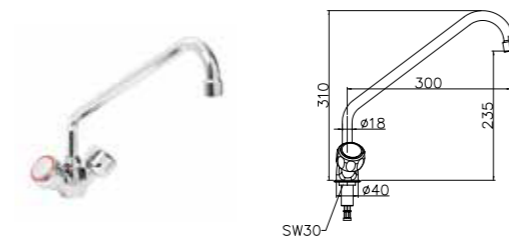

MODEL	CODE	DESCRIPTION	€
FMTH-123	19095065	Mixer faucet with knobs	-

MODEL	CODE	DESCRIPTION	€
FMCL-123	19095066	Gerontological mixer faucet	-

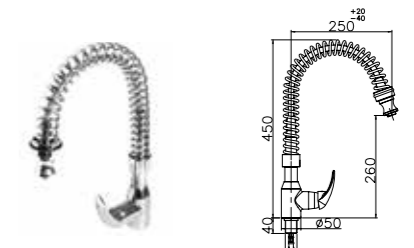
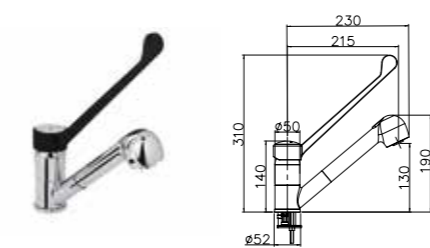

MODEL	CODE	DESCRIPTION	€
FMCL-112R	19095067	Single lever mixer faucet with removable swivel nozzle	-

MODEL	CODE	DESCRIPTION	€
FSMSL-122	19095068	Single lever mixer faucet with springs	-

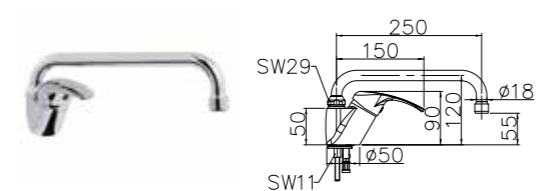

MODEL	CODE	DESCRIPTION	€
FMSL-112	19095070	Single lever mixer faucet with low swivel nozzle	-

Sensor faucets

- Electronic faucet with infrared sensors for opening and closing water flow automatically. Designed for intensive use in professional kitchens.

- Complete hygiene and greater usability, without pedals or buttons.
- Polished chrome plated brass body.
- Automatic closing of solenoid valve in the

event of a power failure or dead battery.
- Connecting tubes and all needed accessories for installation included.
- Mixing valve not included.

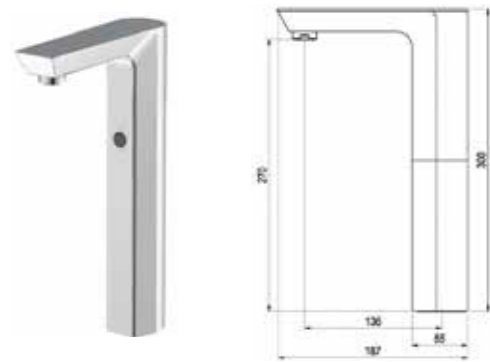

MODEL	CODE	DESCRIPTION	€
FE-121	19095073	Electronic faucet with high nozzle mains-operated	-

MODEL	CODE	DESCRIPTION	€
FE-111	19095074	Electronic faucet mains-operated	-
FE-111 B	19095075	Electronic faucet battery-operated	-

Hose reels

- Hose reel designed for intensive use in food service, meat or fish processing operations, etc.
- Structure and support made entirely of AISI

304 18/10 stainless steel.
- Retractable food grade hose resistant to temperature.

- Hose with locking system allowing to maintain the desired length without effort.
- Wall-mounted configuration.



MODEL	CODE	HOSE LENGTH (m)	€
WOR-10	19101240	10	-
WOR-15	19101242	15	-

Accessories

Foot-operated faucet

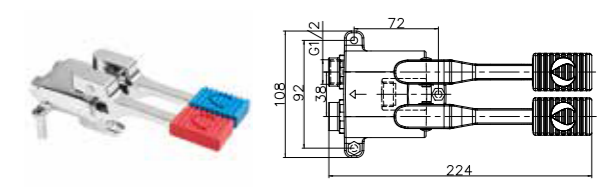
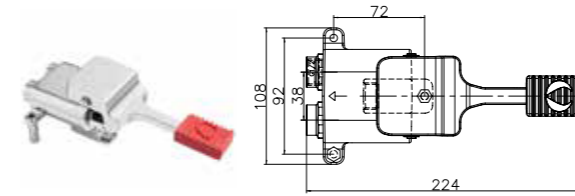

MODEL	CODE	DESCRIPTION	€
FM-1	19095076	Foot-operated two-hole faucet, single	-

MODEL	CODE	DESCRIPTION	€
FM-2	19095077	Foot-operated two-hole faucet, double	-

Other accessories

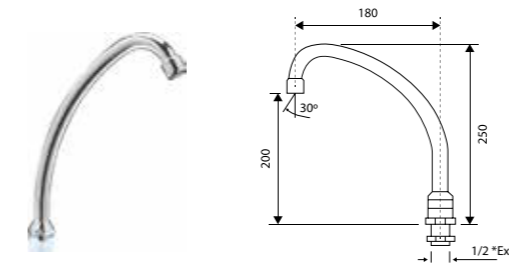

MODEL	CODE	DESCRIPTION	€
FM-111	19095078	High nozzle swing faucet	-

MODEL	CODE	DESCRIPTION	€
FPS-100	19095082	Flexible stainless steel hose with plastic coating resistant to high pressures and temperatures. 1000 mm length. 1/2" connection.	-

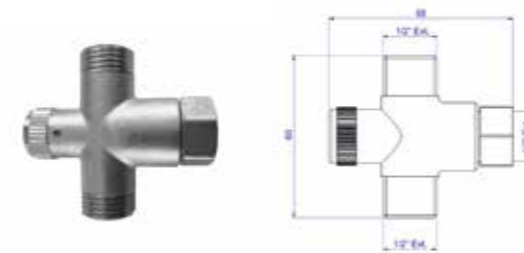

MODEL	CODE	DESCRIPTION	€
MV	19095552	Mixing valve with regulator and back-flow preventer	-

Work tables and cabinets

Work tables.....	447
— Wall-mounted tables	449
— Central tables	451
— Wall-mounted tables with bowl	453
— Work tables 600 mm high	455
— Worktops	457
— Wall-mounted tables with drawers	459
— Corner tables	459
— Waste collection tables	460
— Recycling tables	460
— Countertop shelves	461
— Accessories	462
— Options	465
Cabinets.....	466
— Wall-mounted cabinets	466
— High cabinets	467



Making kitchen daily work easier.

Wall-mounted tables

 Option customization in length



TWDDR3R-614



See options

- Worktop made from AISI-304 18/10 stainless steel with satin finish and reinforced with profiles.
- Backsplash of 100 x 15 mm, 50 mm front edge with welded corners.
- Square section stainless steel legs 40 x 40 mm.
- Rear legs set back 40 mm for floors with sanitary radius.

- 850 mm height with stainless steel height-adjustable feet (-10 mm / + 50 mm).
- Supplied disassembled (except models with doors).
- Option shipped assembled.
- Option door lock.

500 Range



DIMENSIONS (mm)	WITH REINFORCEMENT FRAME		WITH ONE (1) SHELF		WITH TWO (2) SHELVES		WITH DOORS	
	TWLR-5	€	TWS1-5	€	TWS2-5	€	TWD-5	DOOR TYPE
600x500x850	19093246	-	19093257	-	19093268	-	-	-
800x500x850	19093247	-	19093258	-	19093269	-	19093279	Swing
1000x500x850	19093248	-	19093259	-	19093270	-	19093280	Sliding
1200x500x850	19093249	-	19093260	-	19093271	-	19093281	Sliding
1400x500x850	19093250	-	19093261	-	19093272	-	19093282	Sliding
1500x500x850	19093251	-	19093262	-	19093273	-	-	-
1600x500x850	19093252	-	19093263	-	19093274	-	19093283	Sliding
1800x500x850	19093253	-	19093264	-	19093275	-	19093284	Sliding
2000x500x850	19093254	-	19093265	-	19093276	-	19093285	Sliding
2200x500x850	19093255	-	19093266	-	19093277	-	-	-
2400x500x850	19093256	-	19093267	-	19093278	-	-	-

600 Range



DIMENSIONS (mm)	WITH REINFORCEMENT FRAME		WITH ONE (1) SHELF		WITH TWO (2) SHELVES		WITH DOORS		SLIDING DOORS AND DRAWERS		
	TWLR-6		TWS1-6		TWS2-6		TWD-6		TO THE RIGHT		TO THE LEFT
		€		€		€		DOOR TYPE	€	TWDDR3R-6	TWDDR3L-6
600x600x850	19093364	-	19093383	-	19093402	-	-	-	-	-	-
700x600x850	19093365	-	19093384	-	19093403	-	-	-	-	-	-
800x600x850	19093366	-	19093385	-	19093404	-	19093421	Swing	-	-	-
900x600x850	19093367	-	19093386	-	19093405	-	-	-	-	-	-
1000x600x850	19093368	-	19093387	-	19093406	-	19093422	Sliding	-	-	-
1100x600x850	19093369	-	19093388	-	19093407	-	-	-	-	-	-
1200x600x850	19093370	-	19093389	-	19093408	-	19093423	Sliding	-	-	-
1300x600x850	19093371	-	19093390	-	19093409	-	-	-	-	-	-
1400x600x850	19093372	-	19093391	-	19093410	-	19093424	Sliding	-	19093590	19093596
1500x600x850	19093373	-	19093392	-	19093411	-	-	-	-	-	-
1600x600x850	19093374	-	19093393	-	19093412	-	19093425	Sliding	-	19093591	19093597
1700x600x850	19093375	-	19093394	-	19093413	-	-	-	-	-	-
1800x600x850	19093376	-	19093395	-	19093414	-	19093426	Sliding	-	19093592	19093598
1900x600x850	19093377	-	19093396	-	19093415	-	-	-	-	-	-
2000x600x850	19093378	-	19093397	-	19093416	-	19093427	Sliding	-	19093593	19093599
2200x600x850	19093379	-	19093398	-	19093417	-	19093428	Sliding	-	19093594	19093600
2400x600x850	19093380	-	19093399	-	19093418	-	19093429	Sliding	-	19093595	19093601
2600x600x850	19093381	-	19093400	-	19093419	-	19093430	Sliding	-	-	-
2800x600x850	19093382	-	19093401	-	19093420	-	19093431	Sliding	-	-	-

700 Range

DIMENSIONS (mm)	WITH REINFORCEMENT FRAME		WITH ONE (1) SHELF		WITH TWO (2) SHELVES		WITH DOORS		SLIDING DOORS AND DRAWERS		
	TWLR-7		TWS1-7		TWS2-7		TWD-7		TO THE RIGHT		TO THE LEFT
		€		€		€		DOOR TYPE	€	TWDDR3R-7	TWDDR3L-7
600x700x850	19093510	-	19093529	-	19093548	-	-	-	-	-	-
700x700x850	19093511	-	19093530	-	19093549	-	-	-	-	-	-
800x700x850	19093512	-	19093531	-	19093550	-	19093567	Swing	-	-	-
900x700x850	19093513	-	19093532	-	19093551	-	-	-	-	-	-
1000x700x850	19093514	-	19093533	-	19093552	-	19093568	Sliding	-	-	-
1100x700x850	19093515	-	19093534	-	19093553	-	-	-	-	-	-
1200x700x850	19093516	-	19093535	-	19093554	-	19093569	Sliding	-	-	-
1300x700x850	19093517	-	19093536	-	19093555	-	-	-	-	-	-
1400x700x850	19093518	-	19093537	-	19093556	-	19093570	Sliding	-	19093614	19093620
1500x700x850	19093519	-	19093538	-	19093557	-	-	-	-	-	-
1600x700x850	19093520	-	19093539	-	19093558	-	19093571	Sliding	-	19093615	19093621
1700x700x850	19093521	-	19093540	-	19093559	-	-	-	-	-	-
1800x700x850	19093522	-	19093541	-	19093560	-	19093572	Sliding	-	19093616	19093622
1900x700x850	19093523	-	19093542	-	19093561	-	-	-	-	-	-
2000x700x850	19093524	-	19093543	-	19093562	-	19093573	Sliding	-	19093617	19093623
2200x700x850	19093525	-	19093544	-	19093563	-	19093574	Sliding	-	19093618	19093624
2400x700x850	19093526	-	19093545	-	19093564	-	19093575	Sliding	-	19093619	19093625
2600x700x850	19093527	-	19093546	-	19093565	-	19093576	Sliding	-	-	-
2800x700x850	19093528	-	19093547	-	19093566	-	19093577	Sliding	-	-	-

Central tables

 Option customization in length



TCDDR3R-614



See options

- Worktop made from AISI-304 18/10 stainless steel with satin finish and reinforced with profiles.
- 50 mm front edge with welded corners.
- Square section stainless steel legs 40 x 40 mm.
- 850 mm height with stainless steel height-adjustable feet (-10 mm / + 50 mm).

- Supplied disassembled (except models with doors).
- Option shipped assembled.
- Option door lock.

500 Range



DIMENSIONS (mm)	WITH REINFORCEMENT FRAME	€	WITH ONE (1) SHELF	€	WITH TWO (2) SHELVES	€
	TCLR-5		TCS1-5		TCS2-5	
600x500x850	19093213	-	19093224	-	19093235	-
800x500x850	19093214	-	19093225	-	19093236	-
1000x500x850	19093215	-	19093226	-	19093237	-
1200x500x850	19093216	-	19093227	-	19093238	-
1400x500x850	19093217	-	19093228	-	19093239	-
1500x500x850	19093218	-	19093229	-	19093240	-
1600x500x850	19093219	-	19093230	-	19093241	-
1800x500x850	19093220	-	19093231	-	19093242	-
2000x500x850	19093221	-	19093232	-	19093243	-
2200x500x850	19093222	-	19093233	-	19093244	-
2400x500x850	19093223	-	19093234	-	19093245	-

600 Range



DIMENSIONS (mm)	WITH REINFORCEMENT FRAME	€	WITH ONE (1) SHELF	€	WITH TWO (2) SHELVES	€	WITH DOORS	€	PASS-THROUGH DOORS	€	DOOR TYPE	SLIDING DOORS AND DRAWERS		€
	TCLR-6		TCS1-6		TCS2-6		TCD-6		TCDP-6			TO THE RIGHT	TO THE LEFT	
												TCDDR3R-6	TCDDR3L-6	
600x600x850	19093286	-	19093305	-	19093324	-	-	-	-	-	-	-	-	-
700x600x850	19093287	-	19093306	-	19093325	-	-	-	-	-	-	-	-	-
800x600x850	19093288	-	19093307	-	19093326	-	19093343	-	-	-	Swing	-	-	-
900x600x850	19093289	-	19093308	-	19093327	-	-	-	-	-	-	-	-	-
1000x600x850	19093290	-	19093309	-	19093328	-	19093344	-	19093354	-	Sliding	-	-	-
1100x600x850	19093291	-	19093310	-	19093329	-	-	-	-	-	-	-	-	-
1200x600x850	19093292	-	19093311	-	19093330	-	19093345	-	19093355	-	Sliding	-	-	-
1300x600x850	19093293	-	19093312	-	19093331	-	-	-	-	-	-	-	-	-
1400x600x850	19093294	-	19093313	-	19093332	-	19093346	-	19093356	-	Sliding	19093578	19093584	-
1500x600x850	19093295	-	19093314	-	19093333	-	-	-	-	-	-	-	-	-
1600x600x850	19093296	-	19093315	-	19093334	-	19093347	-	19093357	-	Sliding	19093579	19093585	-
1700x600x850	19093297	-	19093316	-	19093335	-	-	-	-	-	-	-	-	-
1800x600x850	19093298	-	19093317	-	19093336	-	19093348	-	19093358	-	Sliding	19093580	19093586	-
1900x600x850	19093299	-	19093318	-	19093337	-	-	-	-	-	-	-	-	-
2000x600x850	19093300	-	19093319	-	19093338	-	19093349	-	19093359	-	Sliding	19093581	19093587	-
2200x600x850	19093301	-	19093320	-	19093339	-	19093350	-	19093360	-	Sliding	19093582	19093588	-
2400x600x850	19093302	-	19093321	-	19093340	-	19093351	-	19093361	-	Sliding	19093583	19093589	-
2600x600x850	19093303	-	19093322	-	19093341	-	19093352	-	19093362	-	Sliding	-	-	-
2800x600x850	19093304	-	19093323	-	19093342	-	19093353	-	19093363	-	Sliding	-	-	-

700 Range

DIMENSIONS (mm)	WITH REINFORCEMENT FRAME	€	WITH ONE (1) SHELF	€	WITH TWO (2) SHELVES	€	WITH DOORS	€	PASS-THROUGH DOORS	€	DOOR TYPE	SLIDING DOORS AND DRAWERS		€
	TCLR-7		TCS1-7		TCS2-7		TCD-7		TCDP-7			TO THE RIGHT	TO THE LEFT	
												TCDDR3R-7	TCDDR3L-7	
600x700x850	19093432	-	19093451	-	19093470	-	-	-	-	-	-	-	-	-
700x700x850	19093433	-	19093452	-	19093471	-	-	-	-	-	-	-	-	-
800x700x850	19093434	-	19093453	-	19093472	-	19093489	-	-	-	Swing	-	-	-
900x700x850	19093435	-	19093454	-	19093473	-	-	-	-	-	-	-	-	-
1000x700x850	19093436	-	19093455	-	19093474	-	19093490	-	19093500	-	Sliding	-	-	-
1100x700x850	19093437	-	19093456	-	19093475	-	-	-	-	-	-	-	-	-
1200x700x850	19093438	-	19093457	-	19093476	-	19093491	-	19093501	-	Sliding	-	-	-
1300x700x850	19093439	-	19093458	-	19093477	-	-	-	-	-	-	-	-	-
1400x700x850	19093440	-	19093459	-	19093478	-	19093492	-	19093502	-	Sliding	19093602	19093608	-
1500x700x850	19093441	-	19093460	-	19093479	-	-	-	-	-	-	-	-	-
1600x700x850	19093442	-	19093461	-	19093480	-	19093493	-	19093503	-	Sliding	19093603	19093609	-
1700x700x850	19093443	-	19093462	-	19093481	-	-	-	-	-	-	-	-	-
1800x700x850	19093444	-	19093463	-	19093482	-	19093494	-	19093504	-	Sliding	19093604	19093610	-
1900x700x850	19093445	-	19093464	-	19093483	-	-	-	-	-	-	-	-	-
2000x700x850	19093446	-	19093465	-	19093484	-	19093495	-	19093505	-	Sliding	19093605	19093611	-
2200x700x850	19093447	-	19093466	-	19093485	-	19093496	-	19093506	-	Sliding	19093606	19093612	-
2400x700x850	19093448	-	19093467	-	19093486	-	19093497	-	19093507	-	Sliding	19093607	19093613	-
2600x700x850	19093449	-	19093468	-	19093487	-	19093498	-	19093508	-	Sliding	-	-	-
2800x700x850	19093450	-	19093469	-	19093488	-	19093499	-	19093509	-	Sliding	-	-	-

Wall-mounted tables with bowl

Option customization in length



TWDDR3R-B1L-614



- Worktop made from AISI-304 18/10 stainless steel with satin finish and reinforced with profiles.
- Backsplash of 100 x 15 mm, 50 mm front edge with welded corners.
- Welded bowl of 500 x 400 x 250 mm.
- Square section stainless steel legs 40 x 40 mm.
- Rear legs set back 40 mm for floors with sanitary radius.
- 850 mm height with stainless steel height-adjustable feet (-10 mm / + 50 mm)..
- Supplied disassembled (except models with doors)
- Option shipped assembled.
- Option door lock.



600 Range



DIMENSIONS (mm)	WITH REINFORCEMENT FRAME			WITH ONE (1) SHELF								
	BOWL TO THE RIGHT TWLR-B1R-6	€	BOWL TO THE LEFT TWLR-B1L-6	€	BOWL IN CENTER TWLR-B1C-6	€	BOWL TO THE RIGHT TWS1-B1R-6	€	BOWL TO THE LEFT TWS1-B1L-6	€	BOWL IN CENTER TWS1-B1C-6	€
1000x600x850	19093626	-	19093637	-	-	-	19093678	-	19093689	-	-	-
1200x600x850	19093627	-	19093638	-	-	-	19093679	-	19093690	-	-	-
1400x600x850	19093628	-	19093639	-	-	-	19093680	-	19093691	-	-	-
1500x600x850	19093629	-	19093640	-	19093648	-	19093681	-	19093692	-	19093700	-
1600x600x850	19093630	-	19093641	-	19093649	-	19093682	-	19093693	-	19093701	-
1800x600x850	19093631	-	19093642	-	19093650	-	19093683	-	19093694	-	19093702	-
2000x600x850	19093632	-	19093643	-	19093651	-	19093684	-	19093695	-	19093703	-
2200x600x850	19093633	-	19093644	-	-	-	19093685	-	19093696	-	-	-
2400x600x850	19093634	-	19093645	-	-	-	19093686	-	19093697	-	-	-
2600x600x850	19093635	-	19093646	-	-	-	19093687	-	19093698	-	-	-
2800x600x850	19093636	-	19093647	-	-	-	19093688	-	19093699	-	-	-



DIMENSIONS (mm)	WITH SLIDING DOORS			WITH SLIDING DOORS AND DRAWERS						
	BOWL TO THE RIGHT TWD-B1R-6	€	BOWL TO THE LEFT TWD-B1L-6	€	BOWL IN CENTER TWD-B1C-6	€	BOWL TO THE RIGHT TWDDR3L-B1R-6	€	BOWL TO THE LEFT TWDDR3R-B1L-6	€
1000x600x850	19093730	-	19093740	-	-	-	-	-	-	-
1200x600x850	19093731	-	19093741	-	-	-	-	-	-	-
1400x600x850	19093732	-	19093742	-	-	-	19093776	-	19093782	-
1600x600x850	19093733	-	19093743	-	19093750	-	19093777	-	19093783	-
1800x600x850	19093734	-	19093744	-	19093751	-	19093778	-	19093784	-
2000x600x850	19093735	-	19093745	-	19093752	-	19093779	-	19093785	-
2200x600x850	19093736	-	19093746	-	-	-	19093780	-	19093786	-
2400x600x850	19093737	-	19093747	-	-	-	19093781	-	19093787	-
2600x600x850	19093738	-	19093748	-	-	-	-	-	-	-
2800x600x850	19093739	-	19093749	-	-	-	-	-	-	-

700 Range



DIMENSIONS (mm)	WITH REINFORCEMENT FRAME			WITH ONE (1) SHELF								
	BOWL TO THE RIGHT TWLR-B1R-7	€	BOWL TO THE LEFT TWLR-B1L-7	€	BOWL IN CENTER TWLR-B1C-7	€	BOWL TO THE RIGHT TWS1-B1R-7	€	BOWL TO THE LEFT TWS1-B1L-7	€	BOWL IN CENTER TWS1-B1C-7	€
1000x700x850	19093652	-	19093663	-	-	-	19093704	-	19093715	-	-	-
1200x700x850	19093653	-	19093664	-	-	-	19093705	-	19093716	-	-	-
1400x700x850	19093654	-	19093665	-	-	-	19093706	-	19093717	-	-	-
1500x700x850	19093655	-	19093666	-	19093674	-	19093707	-	19093718	-	19093726	-
1600x700x850	19093656	-	19093667	-	19093675	-	19093708	-	19093719	-	19093727	-
1800x700x850	19093657	-	19093668	-	19093676	-	19093709	-	19093720	-	19093728	-
2000x700x850	19093658	-	19093669	-	19093677	-	19093710	-	19093721	-	19093729	-
2200x700x850	19093659	-	19093670	-	-	-	19093711	-	19093722	-	-	-
2400x700x850	19093660	-	19093671	-	-	-	19093712	-	19093723	-	-	-
2600x700x850	19093661	-	19093672	-	-	-	19093713	-	19093724	-	-	-
2800x700x850	19093662	-	19093673	-	-	-	19093714	-	19093725	-	-	-



DIMENSIONS (mm)	WITH SLIDING DOORS			WITH SLIDING DOORS AND DRAWERS						
	BOWL TO THE RIGHT TWD-B1R-7	€	BOWL TO THE LEFT TWD-B1L-7	€	BOWL IN CENTER TWD-B1C-7	€	BOWL TO THE RIGHT TWDDR3L-B1R-7	€	BOWL TO THE LEFT TWDDR3R-B1L-7	€
1000x700x850	19093753	-	19093763	-	-	-	-	-	-	-
1200x700x850	19093754	-	19093764	-	-	-	-	-	-	-
1400x700x850	19093755	-	19093765	-	-	-	19093788	-	19093794	-
1600x700x850	19093756	-	19093766	-	19093773	-	19093789	-	19093795	-
1800x700x850	19093757	-	19093767	-	19093774	-	19093790	-	19093796	-
2000x700x850	19093758	-	19093768	-	19093775	-	19093791	-	19093797	-
2200x700x850	19093759	-	19093769	-	-	-	19093792	-	19093798	-
2400x700x850	19093760	-	19093770	-	-	-	19093793	-	19093799	-
2600x700x850	19093761	-	19093771	-	-	-	-	-	-	-
2800x700x850	19093762	-	19093772	-	-	-	-	-	-	-

Work tables 600 mm high

Option customization in length



T6CS1-614



See options

- Designed to support cooking appliances and place the working height at 850-900 mm.
- Worktop made from AISI-304 18/10 stainless steel with satin finish and reinforced with profiles.
- Backsplash of 100 x 15 mm, 50 mm front edge with welded corners.
- Square section stainless steel legs 40 x 40 mm.
- Rear legs set back 40 mm for floors with sanitary radius.
- 600 mm height with stainless steel height-adjustable feet (-10 mm / + 50 mm).
- Supplied disassembled.
- Option shipped assembled.



600 Range



DIMENSIONS (mm)	WALL-MOUNTED TABLE				CENTRAL TABLE			
	WITH REINFORCEMENT FRAME		WITH ONE (1) SHELF		WITH REINFORCEMENT FRAME		WITH ONE (1) SHELF	
	T6WLR-6	€	T6WS1-6	€	T6CLR-6	€	T6CS1-6	€
600x600x600	19093996	-	19094015	-	19093958	-	19093977	-
700x600x600	19093997	-	19094016	-	19093959	-	19093978	-
800x600x600	19093998	-	19094017	-	19093960	-	19093979	-
900x600x600	19093999	-	19094018	-	19093961	-	19093980	-
1000x600x600	19094000	-	19094019	-	19093962	-	19093981	-
1100x600x600	19094001	-	19094020	-	19093963	-	19093982	-
1200x600x600	19094002	-	19094021	-	19093964	-	19093983	-
1300x600x600	19094003	-	19094022	-	19093965	-	19093984	-
1400x600x600	19094004	-	19094023	-	19093966	-	19093985	-
1500x600x600	19094005	-	19094024	-	19093967	-	19093986	-
1600x600x600	19094006	-	19094025	-	19093968	-	19093987	-
1700x600x600	19094007	-	19094026	-	19093969	-	19093988	-
1800x600x600	19094008	-	19094027	-	19093970	-	19093989	-
1900x600x600	19094009	-	19094028	-	19093971	-	19093990	-
2000x600x600	19094010	-	19094029	-	19093972	-	19093991	-
2200x600x600	19094011	-	19094030	-	19093973	-	19093992	-
2400x600x600	19094012	-	19094031	-	19093974	-	19093993	-
2600x600x600	19094013	-	19094032	-	19093975	-	19093994	-
2800x600x600	19094014	-	19094033	-	19093976	-	19093995	-

700 Range



DIMENSIONS (mm)	WALL-MOUNTED TABLE				CENTRAL TABLE			
	WITH REINFORCEMENT FRAME		WITH ONE (1) SHELF		WITH REINFORCEMENT FRAME		WITH ONE (1) SHELF	
	T6WLR-7	€	T6WS1-7	€	T6CLR-7	€	T6CS1-7	€
600x700x600	19094072	-	19094091	-	19094034	-	19094053	-
700x700x600	19094073	-	19094092	-	19094035	-	19094054	-
800x700x600	19094074	-	19094093	-	19094036	-	19094055	-
900x700x600	19094075	-	19094094	-	19094037	-	19094056	-
1000x700x600	19094076	-	19094095	-	19094038	-	19094057	-
1100x700x600	19094077	-	19094096	-	19094039	-	19094058	-
1200x700x600	19094078	-	19094097	-	19094040	-	19094059	-
1300x700x600	19094079	-	19094098	-	19094041	-	19094060	-
1400x700x600	19094080	-	19094099	-	19094042	-	19094061	-
1500x700x600	19094081	-	19094100	-	19094043	-	19094062	-
1600x700x600	19094082	-	19094101	-	19094044	-	19094063	-
1700x700x600	19094083	-	19094102	-	19094045	-	19094064	-
1800x700x600	19094084	-	19094103	-	19094046	-	19094065	-
1900x700x600	19094085	-	19094104	-	19094047	-	19094066	-
2000x700x600	19094086	-	19094105	-	19094048	-	19094067	-
2200x700x600	19094087	-	19094106	-	19094049	-	19094068	-
2400x700x600	19094088	-	19094107	-	19094050	-	19094069	-
2600x700x600	19094089	-	19094108	-	19094051	-	19094070	-
2800x700x600	19094090	-	19094109	-	19094052	-	19094071	-

Worktops

- Worktop made from AISI-304 18/10 stainless steel with satin finish and reinforced with profiles.

- Backsplash of 100 x 15 mm, 50 mm front edge with welded corners.

- Designed to be mounted on wall brackets.



TTC-714



See options

Option customization in length

Flat worktops

600 Range

DIMENSIONS (mm)	WALL-MOUNTED TTW-6	€	CENTRAL TTC-6	€
600x600	19093823	-	19093800	-
700x600	19093824	-	19093801	-
800x600	19093825	-	19093802	-
900x600	19093826	-	19093803	-
1000x600	19093827	-	19093804	-
1100x600	19093828	-	19093805	-
1200x600	19093829	-	19093806	-
1300x600	19093830	-	19093807	-
1400x600	19093831	-	19093808	-
1500x600	19093832	-	19093809	-
1600x600	19093833	-	19093810	-
1700x600	19093834	-	19093811	-
1800x600	19093835	-	19093812	-
1900x600	19093836	-	19093813	-
2000x600	19093837	-	19093814	-
2100x600	19093838	-	19093815	-
2200x600	19093839	-	19093816	-
2300x600	19093840	-	19093817	-
2400x600	19093841	-	19093818	-
2500x600	19093842	-	19093819	-
2600x600	19093843	-	19093820	-
2700x600	19093844	-	19093821	-
2800x600	19093845	-	19093822	-

700 Range

DIMENSIONS (mm)	WALL-MOUNTED TTW-7	€	CENTRAL TTC-7	€
600x700	19093869	-	19093846	-
700x700	19093870	-	19093847	-
800x700	19093871	-	19093848	-
900x700	19093872	-	19093849	-
1000x700	19093873	-	19093850	-
1100x700	19093874	-	19093851	-
1200x700	19093875	-	19093852	-
1300x700	19093876	-	19093853	-
1400x700	19093877	-	19093854	-
1500x700	19093878	-	19093855	-
1600x700	19093879	-	19093856	-
1700x700	19093880	-	19093857	-
1800x700	19093881	-	19093858	-
1900x700	19093882	-	19093859	-
2000x700	19093883	-	19093860	-
2100x700	19093884	-	19093861	-
2200x700	19093885	-	19093862	-
2300x700	19093886	-	19093863	-
2400x700	19093887	-	19093864	-
2500x700	19093888	-	19093865	-
2600x700	19093889	-	19093866	-
2700x700	19093890	-	19093867	-
2800x700	19093891	-	19093868	-



TTW-B1C-614



See options

Worktops with bowl

- Welded bowl of 500 x 400 x 250 mm.

Option customization in length

600 Range

DIMENSIONS (mm)	BOWL TO THE RIGHT TTW-B1R-6	€	BOWL TO THE LEFT TTW-B1L-6	€	BOWL IN CENTER TTW-B1C-6	€
1000x600	19093892	-	19093903	-	19093914	-
1200x600	19093893	-	19093904	-	19093915	-
1400x600	19093894	-	19093905	-	19093916	-
1500x600	19093895	-	19093906	-	19093917	-
1600x600	19093896	-	19093907	-	19093918	-
1800x600	19093897	-	19093908	-	19093919	-
2000x600	19093898	-	19093909	-	19093920	-
2200x600	19093899	-	19093910	-	19093921	-
2400x600	19093900	-	19093911	-	19093922	-
2600x600	19093901	-	19093912	-	19093923	-
2800x600	19093902	-	19093913	-	19093924	-

700 Range

DIMENSIONS (mm)	BOWL TO THE RIGHT TTW-B1R-7	€	BOWL TO THE LEFT TTW-B1L-7	€	BOWL IN CENTER TTW-B1C-7	€
1000x700	19093925	-	19093936	-	19093947	-
1200x700	19093926	-	19093937	-	19093948	-
1400x700	19093927	-	19093938	-	19093949	-
1500x700	19093928	-	19093939	-	19093950	-
1600x700	19093929	-	19093940	-	19093951	-
1800x700	19093930	-	19093941	-	19093952	-
2000x700	19093931	-	19093942	-	19093953	-
2200x700	19093932	-	19093943	-	19093954	-
2400x700	19093933	-	19093944	-	19093955	-
2600x700	19093934	-	19093945	-	19093956	-
2800x700	19093935	-	19093946	-	19093957	-



Wall brackets

- Made from stainless steel.
- Compatible with worktops and 600/700 range sinks, except 600 x 600 mm and pot wash sinks.

DESCRIPTION	MODEL	CODE	€/UNIT
Wall bracket	C-6	19092785	-
Bracket with leg	CP-6	19092786	-

Wall-mounted tables with drawers



See options

- Closed structure with module with three (3) drawers.
- Lower base reinforced with profile to guarantee greater robustness.
- Removable drawers with telescopic sliding guides.

- Effective dimensions of the drawer 304 x 435 x 105 mm.
- 850 mm height with stainless steel height-adjustable feet (-10 mm / + 50 mm).
- Supplied assembled.

RANGE	MODEL	CODE	DIMENSIONS (mm)	DRAWERS	€
600	TWDR3-65	19094112	500x600x850	3	-
700	TWDR3-75	19094113	500x700x850	3	-

Corner tables

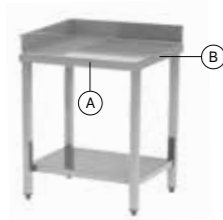

See options

With intermediate shelves

- Shelf made from stainless steel with satin finish and reinforcements in profile.
- Shelf assembly done by fixing four (4) screws.
- 850 mm height with stainless steel height-

- adjustable feet (-10 mm / + 50 mm).
- Supplied disassembled.
- Option shipped assembled.

DIMENSIONS (mm)		MODEL	WITH ONE (1) SHELF	€	MODEL	WITH TWO (2) SHELVES	€
A	B						
600 x 600		T90WS1-66	19094114	-	T90WS2-66	19094118	-
700 x 700		T90WS1-77	19094115	-	T90WS2-77	19094119	-
600 x 700		T90WS1-67	19094116	-	T90WS2-67	19094120	-
700 x 600		T90WS1-76	19094117	-	T90WS2-76	19094121	-



See options

With door

- Closed structure with doors.
- Lower base reinforced with profile to guarantee greater robustness.
- 850 mm height with stainless steel height-

- adjustable feet (-10 mm / + 50 mm).
- Supplied assembled.
- Option door lock.

RANGE	MODEL	CODE	DIMENSIONS (mm)	€
600	T90WD-6	19094122	1000x1000x600x850	-
700	T90WD-7	19094123	1000x1000x700x850	-

Waste collection tables



See options

- Worktop made from AISI-304 18/10 stainless steel with satin finish and reinforced with profiles.
- Sorting hole with rubber ring to throw waste. A waste bin (not included) with maximum diameter of 460 mm could be placed under the counter.
- Backsplash of 100 x 15 mm, 50 mm front edge with welded corners.

- Square section stainless steel legs 40 x 40 mm.
- Rear legs set back 40 mm for floors with sanitary radius.
- 850 mm height with stainless steel height-adjustable feet (-10 mm / + 50 mm).
- Supplied assembled.

RANGE	MODEL	CODE	DIMENSIONS (mm)	€
600	TWD-R-67	19094110	700x600x850	-
700	TWD-R-77	19094111	700x700x850	-

Recycling tables

- Designed for the classification and collection of waste.
- Worktop made from AISI-304 18/10 stainless steel with satin finish and reinforced with profiles.
- Square section stainless steel legs

- 40 x 40 mm.
- Ø195 mm holes for placing rubber rings.
- Rubber ring (not included) to throw waste. A waste bin (not included) with maximum diameter of 460 mm could be placed under the counter.

- 850 mm height with stainless steel height-adjustable feet (-10 mm / + 50 mm).
- Supplied disassembled.
- Option shipped assembled.



See options



See options

Wall-mounted

MODEL	CODE	DIMENSIONS (mm)	HOLES	€
ADULTS				
TWLR-R-612	19094126	1200x600x850	2	-
TWLR-R-617	19094127	1700x600x850	3	-
KIDS <i>kids</i>				
TWLR-R-K-612	19094260	1200x600x700	2	-
TWLR-R-K-617	19094261	1700x600x700	3	-

Central

MODEL	CODE	DIMENSIONS (mm)	HOLES	€
ADULTS				
TCLR-R-612	19094124	1200x600x850	2	-
TCLR-R-617	19094125	1700x600x850	3	-
KIDS <i>kids</i>				
TCLR-R-K-612	19094258	1200x600x700	2	-
TCLR-R-K-617	19094259	1700x600x700	3	-



Rubber ring

- Removable internal Ø162 mm rubber ring that facilitates the identification of the container.
- Easy to clean and disinfect.

MODEL	CODE	COLOR	€
R-Y232	19092787	Yellow	-
R-B232	19092788	Blue	-
R-R232	19092789	Red	-
R-G232	19092790	Green	-

Countertop shelves

 Option customization in length



F2H-313



See options

- Made from stainless steel with satin finish.
- Easy installation by making small holes on the worktop where the joining brackets are placed.
- To be attached to all types of work tables.
- Supplied disassembled.

Single

TABLE SIZE (mm)	DIMENSIONS (mm)	NEUTRAL		Hz	VOLTAGE	HALOGEN LIGHT AND HEAT		POWER (W)	€	CERAMIC HEAT		POWER (W)	€
		F1N-3	€			F1H-3	€			F1C-3	€		
1000	700x350x400	19094128	-	50/60	230V 1N	-	-	-	-	-	-	-	-
1200	900x350x400	19094129	-	50/60	230V 1N	19094138	600	-	19094147	500	-	-	-
1400	1100x350x400	19094130	-	50/60	230V 1N	19094139	600	-	19094148	500	-	-	-
1600	1300x350x400	19094131	-	50/60	230V 1N	19094140	900	-	19094149	750	-	-	-
1800	1500x350x400	19094132	-	50/60	230V 1N	19094141	900	-	19094150	750	-	-	-
2000	1700x350x400	19094133	-	50/60	230V 1N	19094142	1200	-	19094151	1000	-	-	-
2200	1900x350x400	19094134	-	50/60	230V 1N	19094143	1200	-	19094152	1000	-	-	-
2400	2100x350x400	19094135	-	50/60	230V 1N	19094144	1500	-	19094153	1250	-	-	-
2600	2300x350x400	19094136	-	50/60	230V 1N	19094145	1500	-	19094154	1250	-	-	-
2800	2500x350x400	19094137	-	50/60	230V 1N	19094146	1800	-	19094155	1500	-	-	-

Double

TABLE SIZE (mm)	DIMENSIONS (mm)	NEUTRAL		Hz	VOLTAGE	HALOGEN LIGHT AND HEAT		POWER (W)	€	CERAMIC HEAT		POWER (W)	€
		F2N-3	€			F2H-3	€			F2C-3	€		
1000	700x350x700	19094156	-	-	-	-	-	-	-	-	-	-	-
1200	900x350x700	19094157	-	50/60	230V 1N	19094166	1200	-	19094175	1000	-	-	-
1400	1100x350x700	19094158	-	50/60	230V 1N	19094167	1200	-	19094176	1000	-	-	-
1600	1300x350x700	19094159	-	50/60	230V 1N	19094168	1800	-	19094177	1500	-	-	-
1800	1500x350x700	19094160	-	50/60	230V 1N	19094169	1800	-	19094178	1500	-	-	-
2000	1700x350x700	19094161	-	50/60	230V 1N	19094170	2400	-	19094179	2000	-	-	-
2200	1900x350x700	19094162	-	50/60	230V 1N	19094171	2400	-	19094180	2000	-	-	-
2400	2100x350x700	19094163	-	50/60	230V 1N	19094172	3000	-	19094181	2500	-	-	-
2600	2300x350x700	19094164	-	50/60	230V 1N	19094173	3000	-	19094182	2500	-	-	-
2800	2500x350x700	19094165	-	50/60	230V 1N	19094174	3600	-	19094183	3000	-	-	-

Lamp strip



DIMENSIONS (mm)	Hz	VOLTAGE	MODEL	HALOGEN LIGHT AND HEAT	POWER (W)	€	MODEL	CERAMIC HEAT	POWER (W)	€
800x150x60	50/60	230V 1N	H-8	19092791	600	-	C-8	19092795	500	-
1200x150x60	50/60	230V 1N	H-12	19092792	900	-	C-12	19092796	750	-
1600x150x60	50/60	230V 1N	H-16	19092793	1200	-	C-16	19092797	1000	-
2000x150x60	50/60	230V 1N	H-20	19092794	1500	-	C-20	19092798	1250	-

Accessories



Sliding guide drawer kit

- Made from stainless steel.
- Removable drawer equipped with telescopic guides with brake.
- Ease of assembly without the need for welding.
- To be assembled to tables, except in the 500 range.

MODEL	CODE	DIMENSIONS (mm)	€
DR1	19092799	460x450x150	-



Drawer module

- Made from stainless steel.
- Removable drawers equipped with telescopic guides with brake.
- Ease of assembly without the need for welding.
- To be assembled to tables with shelf, except in the 500 range.

RANGE	MODEL	CODE	DIMENSIONS (mm)	DRAWERS	€
600	DR2-64	19092800	465x510x600	2	-
	DR3-64	19092801	465x510x600	3	-
700	DR2-74	19092802	465x610x600	2	-
	DR3-74	19092803	465x610x600	3	-



Large capacity drawer module

- Specially designed to be used as a bread dispenser, to place waste bags or other applications.
- Made from stainless steel.
- Removable drawer equipped with telescopic guides with brake.
- Ease of assembly without the need for welding.
- To be assembled to tables with shelf, except in the 500 range.

RANGE	MODEL	CODE	DIMENSIONS (mm)	€
600	DR1-64	19092804	465x510x600	-
700	DR1-74	19092805	465x610x600	-

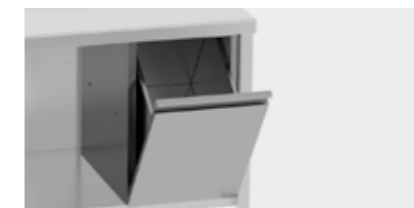

Waste bin hopper module

- Specially designed to be used as a garbage hopper.
- Made from stainless steel.
- Opening with folding lid.
- Ease of assembly without the need for welding.
- To be assembled to tables with shelf, except in the 500 range.

CAPACITY	MODEL	CODE	DIMENSIONS (mm)	€
600	WH-6	19106211	400x510x600	-
700	WH-7	19106212	400x610x600	-



Rack module

- Made from stainless steel.
- Ease of assembly without the need for welding.
- Eight (8) pairs of guides with a separation of 70 mm.
- To be assembled to tables with shelf, except in the 500 range.

CAPACITY	MODEL	CODE	DIMENSIONS (mm)	€
1xGN 1/1	GS-35	19092806	380x560x590	-
600x400	GS-46	19092807	660x436x596	-

Side panel

- Designed to protect walkways and divide storage areas.
- Made from stainless steel.
- Ease of assembly without the need for welding.
- To be assembled to tables with shelf.

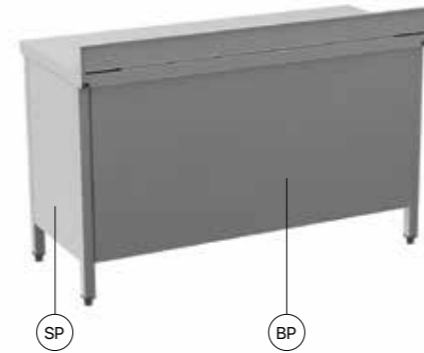

RANGE	MODEL	CODE	€
500	SP-5	19092808	-
600	SP-6	19092809	-
700	SP-7	19092810	-

Back panel

- Designed to protect walkways and divide storage areas.
- Made from stainless steel.
- Ease of assembly without the need for welding.
- To be assembled to tables with shelf.

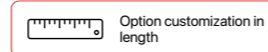

See options

MODEL	TABLE SIZE (mm)	CODE	€
BP-6	600	19094184	-
BP-7	700	19094185	-
BP-8	800	19094186	-
BP-9	900	19094187	-
BP-10	1000	19094188	-
BP-11	1100	19094189	-
BP-12	1200	19094190	-
BP-13	1300	19094191	-
BP-14	1400	19094192	-
BP-15	1500	19094193	-

MODEL	TABLE SIZE (mm)	CODE	€
BP-16	1600	19094194	-
BP-17	1700	19094195	-
BP-18	1800	19094196	-
BP-19	1900	19094197	-
BP-20	2000	19094198	-
BP-22	2200	19094199	-
BP-24	2400	19094200	-
BP-26	2600	19094201	-
BP-28	2800	19094202	-

Detached side splash

- Specially designed to be assembled easily on any sink.
- Made from AISI-304 18/10 stainless steel.

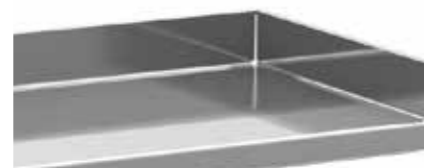

RANGE	MODEL	CODE	POSITION	€
500	TPB-5 R	19092811	Right	-
	TPB-5 L	19092812	Left	-
600	TPB-6 R	19092813	Right	-
	TPB-6 L	19092814	Left	-
700	TPB-7 R	19092815	Right	-
	TPB-7 L	19092816	Left	-

Shelves

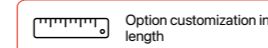

- Made from AISI-304 18/10 stainless steel with satin finish.
- Lower base reinforced with profile to guarantee greater robustness.
- Better space usage since shelves could be added and assembled later.
- Assembly by fixing four (4) screws.



NS-614



See options

TABLE SIZE (mm)	CODE (500 RANGE)	€	CODE (600 RANGE)	€	CODE (700 RANGE)	€
	NS-5		NS-6		NS-7	
600	19094209	-	19094220	-	19094239	-
700	-	--	19094221	-	19094240	-
800	19094210	-	19094222	-	19094241	-
900	-	-	19094223	-	19094242	-
1000	19094211	-	19094224	-	19094243	-
1100	-	-	19094225	-	19094244	-
1200	19094212	-	19094226	-	19094245	-
1300	-	-	19094227	-	19094246	-
1400	19094213	-	19094228	-	19094247	-
1500	19094214	-	19094229	-	19094248	-
1600	19094215	-	19094230	-	19094249	-
1700	-	-	19094231	-	19094250	-
1800	19094216	-	19094232	-	19094251	-
1900	-	-	19094233	-	19094252	-
2000	19094217	-	19094234	-	19094253	-
2200	19094218	-	19094235	-	19094254	-
2400	19094219	-	19094236	-	19094255	-
2600	-	-	19094237	-	19094256	-
2800	-	-	19094238	-	19094257	-

Sorting hole lid

- Specially designed to be placed on the sorting hole to cover it.



MODEL	CODE	€
RL-232	19092820	-

Castor kit

- Ø125 mm castors.
- Assembled in the square legs of 40 x 40 mm.



MODEL	CODE	No. CASTORS	TABLE LENGTH	€
CK-4	19092817	4	<= 2000 mm	-
CK-5	19092818	5	corner tables with door	-
CK-6	19092819	6	> 2000 mm	-

Options

Option shipped assembled.

ABBREVIATION	CODE	DIMENSIONS (mm)	€
A	0201-0001	Up to 1200 mm	-
A	0201-0002	Up to 2000 mm	-
A	0201-0003	Up to 2800 mm	-

Option customization in length

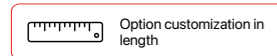

Indicate the code and price of the next higher model and the desired length.

Option stainless steel reinforcements with profile.

DIMENSIONS (mm)	ABBREVIATION	WORKTOP	€	ABBREVIATION	ONE (1) SHELF	€	ABBREVIATION	WORKTOP AND ONE (1) SHELF	€	ABBREVIATION	WORKTOP AND TWO (2) SHELVES	€
Up to 1200 mm	ST	0205-0001	-	SS	0205-0006	-	STS	0205-0011	-	ST2S	0205-0016	-
Up to 1600 mm	ST	0205-0002	-	SS	0205-0007	-	STS	0205-0012	-	ST2S	0205-0017	-
Up to 2000 mm	ST	0205-0003	-	SS	0205-0008	-	STS	0205-0013	-	ST2S	0205-0018	-
Up to 2400 mm	ST	0205-0004	-	SS	0205-0009	-	STS	0205-0014	-	ST2S	0205-0019	-
Up to 2800 mm	ST	0205-0005	-	SS	0205-0010	-	STS	0205-0015	-	ST2S	0205-0020	-

Option door lock.

ABBREVIATION	CODE	DESCRIPTION	€
CR	0206-0001	One (1) lock	-
CR	0206-0002	Two (2) locks	-
CR	0206-0004	Four (4) locks	-

Option faucet hole Ø 33 mm.

ABBREVIATION	CODE	DESCRIPTION	€
33R1	0208-0001	One (1) hole to the right	-
33L1	0208-0002	One (1) hole to the left	-
33C1	0208-0003	One (1) hole centered	-

Option element height.

ABBREVIATION	CODE	DIMENSIONS (mm)	€
H9	0202-0001	900 mm (-10/+50)	-

Note: applies to 600 and 700mm width sinks.

Option 1.5 mm thickness worktop.

ABBREVIATION	CODE	DIMENSIONS (mm)	€
1,5	0204-0001	Up to 1200 mm	-
1,5	0204-0002	Up to 2000 mm	-
1,5	0204-0003	Up to 2800 mm	-

Option side splash folded and welded to the worktop.

ABBREVIATION	CODE	SIDE	€
SPR	0207-0001	Right	-
SPL	0207-0002	Left	-
SPRL	0207-0003 *	Right + Left	-

* Maximum length up to 2600 mm.

Option one (1) sorting hole with black rubber ring on the worktop to throw waste.

ABBREVIATION	CODE	DESCRIPTION	€
RR	0209-0001	One (1) hole with ring to the right	-
RL	0209-0002	One (1) hole with ring to the left	-
RC	0209-0003	One (1) hole with ring centered	-
RCR	0209-0004	One (1) hole with ring on the center right. From 2200 mm worktops on.	-
RCL	0209-0005	One (1) hole with ring on the center left. From 2200 mm worktops on.	-
R	0209-0006	One (1) custom sorting hole.	-

Wall-mounted cabinets



- Specially designed to optimize available space in professional kitchens.
- Entirely made from stainless steel.
- Wall anchor system, including all accessories needed for installation.
- Height-adjustable intermediate shelf.
- Supplied assembled.

Open



MODEL	CODE	DIMENSIONS (mm)	€
CWS1-410	19092847	1000x400x600	-
CWS1-412	19092848	1200x400x600	-
CWS1-414	19092849	1400x400x600	-
CWS1-416	19092850	1600x400x600	-
CWS1-418	19092851	1800x400x600	-

Swing doors



MODEL	CODE	DIMENSIONS (mm)	No. DOORS	€
CWHD-45	19092845	500x400x600	1	-
CWHD-410	19092846	1000x400x600	2	-

Sliding doors



MODEL	CODE	DIMENSIONS (mm)	€
CWD-410	19092852	1000x400x600	-
CWD-412	19092853	1200x400x600	-
CWD-414	19092854	1400x400x600	-
CWD-416	19092855	1600x400x600	-
CWD-418	19092856	1800x400x600	-

Corner cabinet with door



- Model to join wall-mounted cabinets in 90° angle corners.

MODEL	CODE	DIMENSIONS (mm)	€
C90WD-4	19092859	700x400x600	-

Sliding doors with drainer



- Model with storing capacity of 36 plates with max Ø280 mm.

MODEL	CODE	DIMENSIONS (mm)	€
CWDD-410	19092857	1000x400x600	-
CWDD-412	19092858	1200x400x600	-

Hanging spice rack



- Made of stainless steel.
- Support for pans to be placed under the cabinets (pans not included).

MODEL	CODE	€
GNS-4	19092860	-

FOR CABINETS LENGTH (MM)	QUANTITY OF SPICE RACKS TO ORDER
500	2
1000	5
1200	6
1400	7
1600	8
1800	9

High cabinets

Cupboards

- Specially designed to optimize available space in professional kitchens.
- Entirely made from stainless steel.
- Three (3) intermediate stainless steel shelves with reinforcements in

profile. The central shelf is fixed, the other two are height-adjustable.
- Key lock included.
- Supplied assembled.

With swing doors



MODEL	CODE	DIMENSIONS (mm)	No. DOORS	€
CSHD-66	19092862	600x600x1900	1	-
CSHD-610	19092863	1000x600x1900	2	-

With sliding doors



MODEL	CODE	DIMENSIONS (mm)	€
CSD-612	19092864	1200x600x1900	-
CSD-614	19092865	1400x600x1900	-
CSD-616	19092866	1600x600x1900	-

Janitorial cabinets

- Specially designed to optimize available space in professional kitchens.
- Entirely made from stainless steel.
- Three (3) intermediate stainless steel shelves with reinforcements in profile. The central shelf is fixed, the other two are height-adjustable.
- Key lock included.



MODEL	CODE	DIMENSIONS (mm)	No. DOORS	€
CCHD-66	19092874	600x600x1900	1	-
CCHD-610	19092875	1000x600x1900	2	-

Sloped roof

- Specially designed to prevent dust and dirt built-up on the upper part of the cabinet.
- Made of stainless steel.
- Easy installation on cupboards



DIMENSIONS (mm)	MODEL	CODE	€
600x600x200	CSHDIP-66	19092867	-
1000x600x200	CSHDIP-610	19092868	-
1200x600x200	CSDIP-612	19092871	-
1400x600x200	CSDIP-614	19092872	-
1600x600x200	CSDIP-616	19092873	-

Utensil bar

- Made of AISI 304 18/10 stainless steel
- Welded plates with holes to fix to the wall (plugs and screws included).

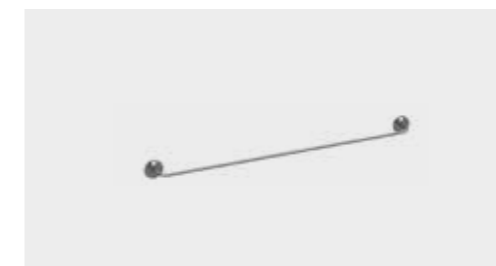

MODEL	CODE	DIMENSIONS (mm)	€
UH-6	19092861	600x40x40	-

Neutral-hot element composition

- Elements with shelves.....471
- Elements with sliding doors.....472
- Elements with swing doors.....473
- Elements with drawers.....474
- Elements with sliding doors and drawers.....475
- Hot elements.....477
- Elements with rack module.....478
- 600 mm height elements.....479
- Corner elements.....480
- Waste collection elements.....480
- Elements with sink.....481
- Worktops.....483
- Recycling station elements.....485
- Accessories.....486
- Options.....487

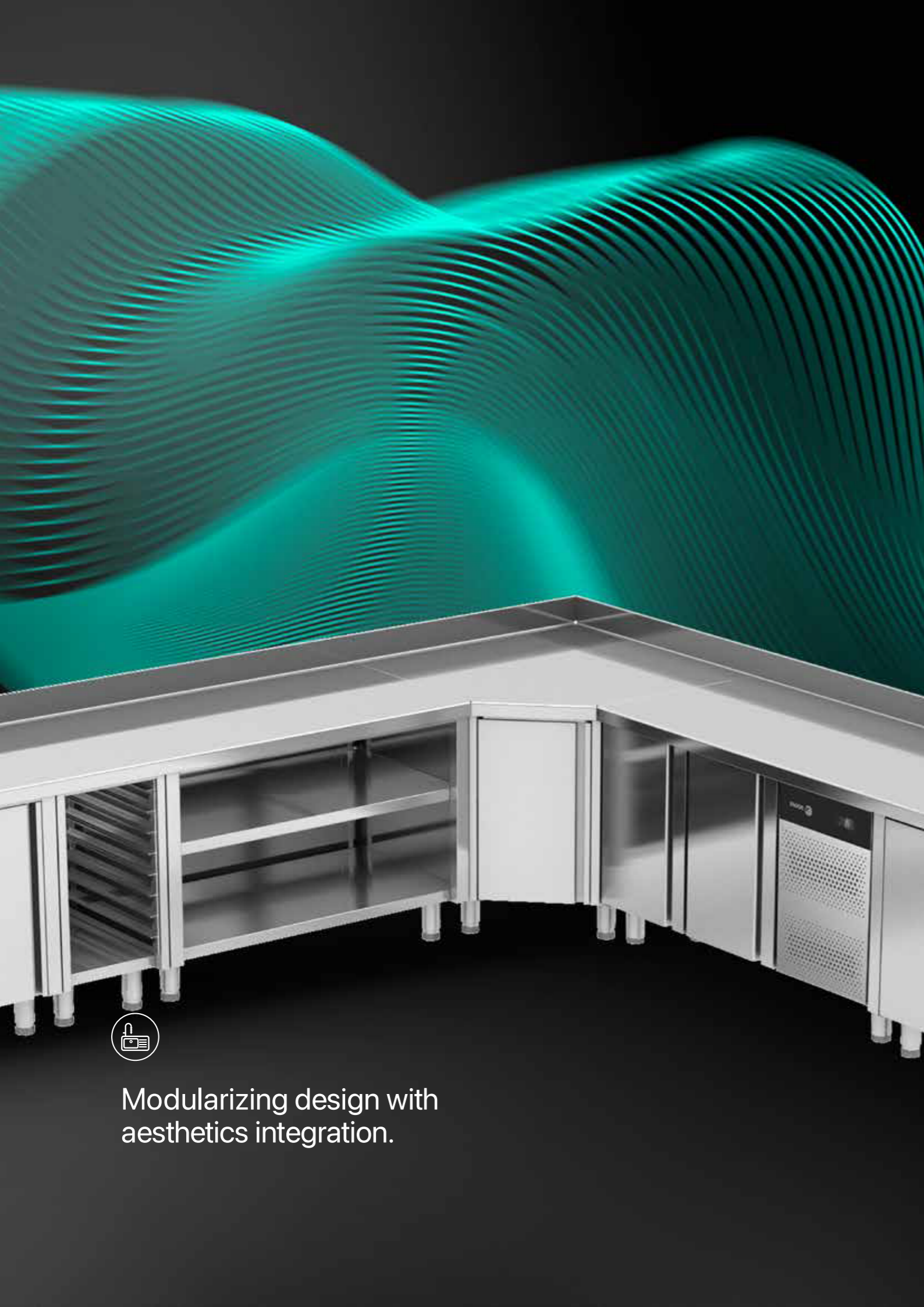

Modularizing design with aesthetics integration.

Elements with shelves

 Option customization in length



TMWS1-614

 See options

- Worktop made from AISI-304 18/10 stainless steel with satin finish.
- Backsplash of 100 x 15 mm and 50 mm front edge with welded corners.
- Modular element with closed structure made from stainless steel, fully integrable with the rest of neutral and hot elements, through a common or independent worktop.
- Lower base reinforced with profile to guarantee greater robustness.

- 850 mm height with stainless steel height-adjustable feet (-10 mm / + 50 mm).
- Supplied assembled.

600 Range



DIMENSIONS (mm)	WALL-MOUNTED TMWS1-6	€	CENTRAL TMCS1-6	€	WITHOUT WORKTOP TMS1-6 SE	€	PASSTHROUGH TMPS1-6	€	PASSTHROUGH WITHOUT WORKTOP TMPS1-6 SE	€
600x600x850	19094353	-	19094363	-	19094373	-	19094313	-	19094323	-
800x600x850	19094354	-	19094364	-	19094374	-	19094314	-	19094324	-
1000x600x850	19094355	-	19094365	-	19094375	-	19094315	-	19094325	-
1200x600x850	19094356	-	19094366	-	19094376	-	19094316	-	19094326	-
1400x600x850	19094357	-	19094367	-	19094377	-	19094317	-	19094327	-
1600x600x850	19094358	-	19094368	-	19094378	-	19094318	-	19094328	-
1800x600x850	19094359	-	19094369	-	19094379	-	19094319	-	19094329	-
2000x600x850	19094360	-	19094370	-	19094380	-	19094320	-	19094330	-
2200x600x850	19094361	-	19094371	-	19094381	-	19094321	-	19094331	-
2400x600x850	19094362	-	19094372	-	19094382	-	19094322	-	19094332	-

700 Range

DIMENSIONS (mm)	WALL-MOUNTED TMWS1-7	€	CENTRAL TMCS1-7	€	WITHOUT WORKTOP TMS1-7 SE	€	PASSTHROUGH TMPS1-7	€	PASSTHROUGH WITHOUT WORKTOP TMPS1-7 SE	€
600x700x850	19094383	-	19094393	-	19094403	-	19094333	-	19094343	-
800x700x850	19094384	-	19094394	-	19094404	-	19094334	-	19094344	-
1000x700x850	19094385	-	19094395	-	19094405	-	19094335	-	19094345	-
1200x700x850	19094386	-	19094396	-	19094406	-	19094336	-	19094346	-
1400x700x850	19094387	-	19094397	-	19094407	-	19094337	-	19094347	-
1600x700x850	19094388	-	19094398	-	19094408	-	19094338	-	19094348	-
1800x700x850	19094389	-	19094399	-	19094409	-	19094339	-	19094349	-
2000x700x850	19094390	-	19094400	-	19094410	-	19094340	-	19094350	-
2200x700x850	19094391	-	19094401	-	19094411	-	19094341	-	19094351	-
2400x700x850	19094392	-	19094402	-	19094412	-	19094342	-	19094352	-

Elements with sliding doors

 Option customization in length



TMWD-614

 See options

- Worktop made from AISI-304 18/10 stainless steel with satin finish.
- Backsplash of 100 x 15 mm and 50 mm front edge with welded corners.
- Modular element with closed structure made from stainless steel, fully integrable with the rest of neutral and hot elements, through a common or independent worktop.
- Lower base reinforced with profile to guarantee greater robustness.

- 850 mm height with stainless steel height-adjustable feet (-10 mm / + 50 mm).
- Supplied assembled.
- Option door lock.

600 Range



DIMENSIONS (mm)	WALL-MOUNTED TMWD-6	€	CENTRAL TMCD-6	€	WITHOUT WORKTOP TMD-6 SE	€	FOR WORK-TOPS WITH BOWL TMD-6 OB SE	€	PASSTHROUGH TMDP-6	€	PASSTHROUGH WITHOUT WORKTOP TMDP-6 SE	€
1000x600x850	19094437	-	19094443	-	19094449	-	19094455	-	19094413	-	19094419	-
1200x600x850	19094438	-	19094444	-	19094450	-	19094456	-	19094414	-	19094420	-
1400x600x850	19094439	-	19094445	-	19094451	-	19094457	-	19094415	-	19094421	-
1600x600x850	19094440	-	19094446	-	19094452	-	19094458	-	19094416	-	19094422	-
1800x600x850	19094441	-	19094447	-	19094453	-	19094459	-	19094417	-	19094423	-
2000x600x850	19094442	-	19094448	-	19094454	-	19094460	-	19094418	-	19094424	-

700 Range

DIMENSIONS (mm)	WALL-MOUNTED TMWD-7	€	CENTRAL TMCD-7	€	WITHOUT WORKTOP TMD-7 SE	€	FOR WORK-TOPS WITH BOWL TMD-7 OB SE	€	PASSTHROUGH TMDP-7	€	PASSTHROUGH WITHOUT WORKTOP TMDP-7 SE	€
1000x700x850	19094461	-	19094467	-	19094473	-	19094479	-	19094425	-	19094431	-
1200x700x850	19094462	-	19094468	-	19094474	-	19094480	-	19094426	-	19094432	-
1400x700x850	19094463	-	19094469	-	19094475	-	19094481	-	19094427	-	19094433	-
1600x700x850	19094464	-	19094470	-	19094476	-	19094482	-	19094428	-	19094434	-
1800x700x850	19094465	-	19094471	-	19094477	-	19094483	-	19094429	-	19094435	-
2000x700x850	19094466	-	19094472	-	19094478	-	19094484	-	19094430	-	19094436	-

Elements with swing doors



TMWHD-68



See options

- Worktop made from AISI-304 18/10 stainless steel with satin finish.
- Backsplash of 100 x 15 mm and 50 mm front edge with welded corners.
- Modular element with closed structure made from stainless steel, fully integrable with the rest of neutral and hot elements, through a common or independent worktop.
- Lower base reinforced with profile to guarantee greater robustness.
- 850 mm height with stainless steel height-adjustable feet (-10 mm / + 50 mm).
- Supplied assembled.
- Option door lock.



600 Range

DIMENSIONS (mm)	WALL-MOUNTED	€	CENTRAL	€	WITHOUT WORKTOP	€	FOR WORKTOPS WITH BOWL	€	PASSTHROUGH	€	PASSTHROUGH-WITHOUT WORKTOP	€
	TMWHD-6		TMCHD-6		TMHD-6 SE		TMHD-6 OB SE		TMCHDP-6		TMHDP-6 SE	
400x600x850	19094497	-	19094501	-	19094505	-	-	-	19094527	-	19094531	-
600x600x850	19094498	-	19094502	-	19094506	-	19094509	-	19094528	-	19094532	-
800x600x850	19094499	-	19094503	-	19094507	-	19094510	-	19094529	-	19094533	-
1000x600x850	19094500	-	19094504	-	19094508	-	19094511	-	19094530	-	19094534	-

700 Range

DIMENSIONS (mm)	WALL-MOUNTED	€	CENTRAL	€	WITHOUT WORKTOP	€	FOR WORKTOPS WITH BOWL	€	PASSTHROUGH	€	PASSTHROUGH-WITHOUT WORKTOP	€
	TMWHD-7		TMCHD-7		TMHD-7 SE		TMHD-7 OB SE		TMCHDP-7		TMHDP-7 SE	
400x700x850	19094512	-	19094516	-	19094520	-	-	-	19094535	-	19094539	-
600x700x850	19094513	-	19094517	-	19094521	-	19094524	-	19094536	-	19094540	-
800x700x850	19094514	-	19094518	-	19094522	-	19094525	-	19094537	-	19094541	-
1000x700x850	19094515	-	19094519	-	19094523	-	19094526	-	19094538	-	19094542	-

Elements with drawers or hopper



TMWDR3-64



TMWDR1-66



TMWWH-66



See options

- Worktop made from AISI-304 18/10 stainless steel with satin finish.
- Backsplash of 100 x 15 mm and 50 mm front edge with welded corners.
- Modular element with closed structure made from stainless steel, fully integrable with the rest of neutral and hot elements, through a common or independent worktop.
- Lower base reinforced with profile to guarantee greater robustness.
- 850 mm height elements with stainless steel height-adjustable feet (-10 mm / + 50 mm)..
- Supplied assembled.

Element with 3 drawers

- Module with three (3) drawers.
- Removable drawers with telescopic sliding guides.
- Effective dimensions of the drawer 304 x 435 x 105 mm.



RANGE	DIMENSIONS (mm)	MODEL	WALL-MOUNTED	€	MODEL	CENTRAL	€	MODEL	WITHOUT WORKTOP	€
600	400x600x850	TMWDR3-64	19094485	-	TMCDR3-64	19094486	-	TMDR3-64 SE	19094487	-
700	400x700x850	TMWDR3-74	19094488	-	TMCDR3-74	19094489	-	TMDR3-74 SE	19094490	-

Element with large capacity drawer

- Specially designed to be used as a bread dispenser, to place waste bags or other applications.
- Removable drawer equipped with telescopic guides with brake.



RANGE	DIMENSIONS (mm)	MODEL	WALL-MOUNTED	€	MODEL	CENTRAL	€	MODEL	WITHOUT WORKTOP	€
600	600x600x850	TMWDR1-66	19094491	-	TMCDR1-66	19094492	-	TMDR1-66 SE	19094493	-
700	600x700x850	TMWDR1-76	19094494	-	TMCDR1-76	19094495	-	TMDR1-76 SE	19094496	-

Elements with hopper

- Specially designed to be used as a bread dispenser, to place waste bags or other applications.
- Opening with folding lid.



RANGE	DIMENSIONS (mm)	MODEL	WALL-MOUNTED	€	MODEL	CENTRAL	€	MODEL	WITHOUT WORKTOP	€
600	600x600x850	TMWWH-66	19106416	-	TMCWH-66	19106418	-	TMWH-66 SE	19106421	-
700	600x700x850	TMWWH-76	19106417	-	TMCWH-76	19106420	-	TMWH-76 SE	19106422	-

Elements with sliding doors and drawers



TMWDDR3R-614



TMWDDR3L-614

Option customization in length



See options

- Worktop made from AISI-304 18/10 stainless steel with satin finish.
- Backsplash of 100 x 15 mm and 50 mm front edge with welded corners.
- Modular element with closed structure made from stainless steel, fully integrable with the rest of neutral and hot elements, through a common or independent worktop.
- Lower base reinforced with profile to guarantee greater robustness.
- 850 mm height elements with stainless steel height-adjustable feet (-10 mm / + 50 mm).

- Intermediate shelf made from stainless steel, adjustable in height and reinforced with profiles.
- Module with three (3) drawers included.
- Removable drawers with telescopic sliding guides.
- Effective dimensions of the drawer 304 x 435 x 105 mm.
- Supplied assembled.
- Option door lock.



Drawers at the right



600 Range

DIMENSIONS (mm)	WALL-MOUNTED	€	CENTRAL	€	WITHOUT WORKTOP	€
	TMWDDR3R-6		TMCDDR3R-6		TMDDR3R-6 SE	
1400x600x850	19094579	-	19094585	-	19094591	-
1600x600x850	19094580	-	19094586	-	19094592	-
1800x600x850	19094581	-	19094587	-	19094593	-
2000x600x850	19094582	-	19094588	-	19094594	-
2200x600x850	19094583	-	19094589	-	19094595	-
2400x600x850	19094584	-	19094590	-	19094596	-

700 Range

DIMENSIONS (mm)	WALL-MOUNTED	€	CENTRAL	€	WITHOUT WORKTOP	€
	TMWDDR3R-7		TMCDDR3R-7		TMDDR3R-7 SE	
1400x700x850	19094597	-	19094603	-	19094609	-
1600x700x850	19094598	-	19094604	-	19094610	-
1800x700x850	19094599	-	19094605	-	19094611	-
2000x700x850	19094600	-	19094606	-	19094612	-
2200x700x850	19094601	-	19094607	-	19094613	-
2400x700x850	19094602	-	19094608	-	19094614	-

Drawers at the left



600 Range

DIMENSIONS (mm)	WALL-MOUNTED	€	CENTRAL	€	WITHOUT WORKTOP	€
	TMWDDR3L-6		TMCDDR3L-6		TMDDR3L-6 SE	
1400x600x850	19094543	-	19094549	-	19094555	-
1600x600x850	19094544	-	19094550	-	19094556	-
1800x600x850	19094545	-	19094551	-	19094557	-
2000x600x850	19094546	-	19094552	-	19094558	-
2200x600x850	19094547	-	19094553	-	19094559	-
2400x600x850	19094548	-	19094554	-	19094560	-

700 Range

DIMENSIONS (mm)	WALL-MOUNTED	€	CENTRAL	€	WITHOUT WORKTOP	€
	TMWDDR3L-7		TMCDDR3L-7		TMDDR3L-7 SE	
1400x700x850	19094561	-	19094567	-	19094573	-
1600x700x850	19094562	-	19094568	-	19094574	-
1800x700x850	19094563	-	19094569	-	19094575	-
2000x700x850	19094564	-	19094570	-	19094576	-
2200x700x850	19094565	-	19094571	-	19094577	-
2400x700x850	19094566	-	19094572	-	19094578	-

Hot elements



TMWH-614



See options

- Worktop made from AISI-304 18/10 stainless steel with satin finish.
- Backsplash of 100 x 15 mm and 50 mm front edge with welded corners.
- Modular element with closed structure made from stainless steel, fully integrable with the rest of neutral elements, through a common or independent worktop.
- Lower base reinforced with profile to guarantee greater robustness.
- 850 mm height elements with stainless steel height-adjustable feet (-10 mm / + 50 mm).

- Forced hot air distribution system. Resistor-fan system enables a fast heating up and produces an efficient air circulation inside.
- Wool rock insulation.
- Electronic thermostat, with digital display, to control and regulate the temperature at desired set point.
- Working temperature: from +30 °C to +90 °C.
- Supplied assembled.
- Option door lock .

600 Range



DIMENSIONS (mm)	Hz	VOLTAGE	POWER (W)	WALL-MOUNTED TMWH-6	€	CENTRAL TMCH-6	€	WITHOUT WORKTOP TMH-6 SE	€
1200x600x850	50/60	230V 1N	1565	19094681	-	19094645	-	19094649	-
1400x600x850	50/60	230V 1N	1565	19094682	-	19094646	-	19094650	-
1600x600x850	50/60	230V 1N	2600	19094683	-	19094647	-	19094651	-
1800x600x850	50/60	230V 1N	2600	19094684	-	19094648	-	19094652	-



DIMENSIONS (mm)	Hz	VOLTAGE	POWER (W)	PASSTHROUGH TMPH-6	€	PASSTHROUGH WITHOUT WORKTOP TMPH-6 SE	€
1200x600x850	50/60	230V 1N	1565	19094663	-	19094667	-
1400x600x850	50/60	230V 1N	2600	19094664	-	19094668	-
1600x600x850	50/60	230V 1N	2600	19094665	-	19094669	-
1800x600x850	50/60	230V 1N	3000	19094666	-	19094670	-

700 Range



DIMENSIONS (mm)	Hz	VOLTAGE	POWER (W)	WALL-MOUNTED TMWH-7	€	CENTRAL TMCH-7	€	WITHOUT WORKTOP TMH-7 SE	€
1200x700x850	50/60	230V 1N	1565	19094685	-	19094653	-	19094658	-
1400x700x850	50/60	230V 1N	1565	19094686	-	19094654	-	19094659	-
1600x700x850	50/60	230V 1N	2600	19094687	-	19094655	-	19094660	-
1800x700x850	50/60	230V 1N	2600	19094688	-	19094656	-	19094661	-
2000x700x850	50/60	230V 1N	3000	19094689	-	19094657	-	19094662	-



DIMENSIONS (mm)	Hz	VOLTAGE	POWER (W)	PASSTHROUGH TMPH-7	€	PASSTHROUGH WITHOUT WORKTOP TMPH-7 SE	€
1200x700x850	50/60	230V 1N	2600	19094671	-	19094676	-
1400x700x850	50/60	230V 1N	2600	19094672	-	19094677	-
1600x700x850	50/60	230V 1N	2600	19094673	-	19094678	-
1800x700x850	50/60	230V 1N	3000	19094674	-	19094679	-
2000x700x850	50/60	230V 1N	3000	19094675	-	19094680	-

Elements with rack module



TMC-78 GN



See options

- Worktop made from AISI-304 18/10 stainless steel with satin finish.
- Backsplash of 100 x 15 mm and 50 mm front edge with welded corners.
- Modular element with closed structure made from stainless steel, fully integrable with the rest of neutral and hot elements, through a common or independent worktop.
- Designed to store grids or pans.
- Lower base reinforced with profile to guarantee greater robustness.
- 850 mm height elements with stainless steel height-adjustable feet (-10 mm / + 50 mm).
- Supplied assembled.

600 Range

CAPACITY	DIMENSIONS (mm)	MODEL	WALL-MOUNTED	€	MODEL	CENTRAL	€	MODEL	WITHOUT WORKTOP	€
1xGN 1/1	400x600x850	TMW-64 GN	19094627	-	TMC-64 GN	19094629	-	TM-64 GN SE	19094631	-
2xGN 1/1	800x600x850	TMW-68 GN	19094628	-	TMC-68 GN	19094630	-	TM-68 GN SE	19094632	-

700 Range

CAPACITY	DIMENSIONS (mm)	MODEL	WALL-MOUNTED	€	MODEL	CENTRAL	€	MODEL	WITHOUT WORKTOP	€
1xGN 1/1	400x700x850	TMW-74 GN	19094633	-	TMC-74 GN	19094637	-	TM-74 GN SE	19094641	-
1x600x400	500x700x850	TMW-75 P	19094634	-	TMC-75 P	19094638	-	TM-75 P SE	19094642	-
2xGN 1/1	800x700x850	TMW-78 GN	19094635	-	TMC-78 GN	19094639	-	TM-78 GN SE	19094643	-
2x600x400	1000x700x850	TMW-710 P	19094636	-	TMC-710 P	19094640	-	TM-710 P SE	19094644	-

600 mm height elements



TM6W-612

Option customization in length



TM6WHD-68

See options

- Worktop made from AISI-304 18/10 stainless steel with satin finish.
- Backsplash of 100 x 15 mm and 50 mm front edge with welded corners.
- Modular element with closed structure made from stainless steel, fully integrable with the rest of 600 mm-height neutral elements, through a common or independent worktop.

- Lower base reinforced with profile to guarantee greater robustness.
- Designed to support cooking appliances and place the working height at 850-900 mm. With stainless steel height-adjustable feet (-10 mm / + 50 mm).
- Supplied assembled.
- Option door lock (Elements with swing doors).

Open elements



DIMENSIONS (mm)	WALL-MOUNTED		CENTRAL		WITHOUT WORKTOP	
	TM6W-6 TM6W-7	€	TM6C-6 TM6C-7	€	TM6-6 SE TM6-7 SE	€
600 RANGE						
600x600x600	19094690	-	19094696	-	19094702	-
800x600x600	19094691	-	19094697	-	19094703	-
1000x600x600	19094692	-	19094698	-	19094704	-
1200x600x600	19094693	-	19094699	-	19094705	-
1400x600x600	19094694	-	19094700	-	19094706	-
1600x600x600	19094695	-	19094701	-	19094707	-
700 RANGE						
600x700x600	19094708	-	19094714	-	19094720	-
800x700x600	19094709	-	19094715	-	19094721	-
1000x700x600	19094710	-	19094716	-	19094722	-
1200x700x600	19094711	-	19094717	-	19094723	-
1400x700x600	19094712	-	19094718	-	19094724	-
1600x700x600	19094713	-	19094719	-	19094725	-

Elements with swing doors



DIMENSIONS (mm)	WALL-MOUNTED		CENTRAL		WITHOUT WORKTOP	
	TM6WHD-6 TM6WHD-7	€	TM6CHD-6 TM6CHD-7	€	TM6HD-6 SE TM6HD-7 SE	€
600 RANGE						
400x600x600	19094726	-	19094730	-	19094734	-
600x600x600	19094727	-	19094731	-	19094735	-
800x600x600	19094728	-	19094732	-	19094736	-
1000x600x600	19094729	-	19094733	-	19094737	-
700 RANGE						
400x700x600	19094738	-	19094742	-	19094746	-
600x700x600	19094739	-	19094743	-	19094747	-
800x700x600	19094740	-	19094744	-	19094748	-
1000x700x600	19094741	-	19094745	-	19094749	-

Corner elements



TM90W-6 R



See options

- Worktop made from AISI-304 18/10 stainless steel with satin finish.
- Backsplash of 100 x 15 mm and 50 mm front edge with welded corners.
- Modular element with closed structure made from stainless steel, fully integrable with the rest of neutral and hot elements, through an independent worktop.
- Designed to optimize the space in the corners while maintaining a homogeneous line next to neutral and hot elements.

- Lower base reinforced with profile to guarantee greater robustness.
- 850 mm height elements with stainless steel height-adjustable feet (-10 mm / + 50 mm).
- Supplied assembled.
- Option door lock.

Closed corner elements

- Specially designed with a coupling module for one (1) swing door to facilitate the connection to another worktop.

- Requires worktop with 500 mm overhang on coupling module.
- Straight corners.

600 Range

MODEL	CODE	DIMENSIONS (mm)	POSITION	€
TM90W-6 R	19094621	1100x600x850	Right	-
TM90W-6 L	19094622	1100x600x850	Left	-

700 Range

MODEL	CODE	DIMENSIONS (mm)	POSITION	€
TM90W-7 R	19094623	1200x700x850	Right	-
TM90W-7 L	19094624	1200x700x850	Left	-

Corner elements with door

600 Range

MODEL	CODE	DIMENSIONS (mm)	€
TM90WD-6	19094625	1000x1000x600x850	-

700 Range

MODEL	CODE	DIMENSIONS (mm)	€
TM90WD-7	19094626	1000x1000x700x850	-

Waste collection elements

See options

- Corner elements with door
- Modular element with closed structure made from stainless steel, fully integrable with the rest of neutral and hot elements, through a common or independent worktop.
- 850 mm height elements with stainless steel height-adjustable feet (-10 mm / + 50 mm).

- Sorting hole with rubber ring to throw waste. A waste bin (not included) with maximum diameter of 360 mm could be placed under the counter.
- Supplied assembled.



RANGE	DIMENSIONS (mm)	MODEL	WALL-MOUNTED		CENTRAL		WITHOUT WORKTOP			
			€	€	€	€				
600	600x600x850	TMWD-R-66	19094615	-	TMCD-R-66	19094616	-	TMD-R-66 SE	19094617	-
700	600x700x850	TMWD-R-76	19094618	-	TMCD-R-76	19094619	-	TMD-R-76 SE	19094620	-

Elements with sink



See options

- Modular element with closed structure made from stainless steel, fully integrable with the rest of neutral elements, through an independent worktop.
- Lower base reinforced with profile to guarantee greater robustness.
- 850 mm height elements with stainless steel height-adjustable feet (-10 mm / + 50 mm).
- Worktop fully made from AISI-304 18/10 stainless steel, 1 mm thickness and overflow rim.

- Single-pressed, sound-proof bowls.
- Drain valve and overflow pipe for each bowl.
- Backsplash of 100 x 15 mm and 50 mm front edge with welded corners.
- Supplied assembled.
- Option door lock.



600 Range

MODEL	DIMENSIONS (mm)	BOWL DIMENSIONS (mm)	ELEMENTS WITH DOORS	DOOR TYPE	€	ELEMENTS WITH DOORS AND SPACE FOR UNDERCOUNTER DISHWASHER		€
						D	WD	
SKM-66	600x600	B1	500x400x250	19094750	Swing	-	-	-
SKM-610	1000x600	B1 D1R	400x400x250	19094751	Sliding	-	-	-
		B1 D1L	400x400x250	19094752	Sliding	-	-	-
		B2	400x400x250	19094753	Sliding	-	-	-
SKM-612	1200x600	B1 D1R	500x400x250	19094754	Sliding	-	19094766	Swing
		B1 D1L	500x400x250	19094755	Sliding	-	19094767	Swing
		B2	500x400x250	19094756	Sliding	-	-	-
SKM-614	1400x600	B2 D1R	400x400x250	19094757	Sliding	-	-	-
		B2 D1L	400x400x250	19094758	Sliding	-	-	-
		B1 D1R	500x400x250	19094759	Sliding	-	19094768	Swing
		B1 D1L	500x400x250	19094760	Sliding	-	19094769	Swing
SKM-616	1600x600	B2 D1R	500x400x250	19094761	Sliding	-	-	-
		B2 D1L	500x400x250	19094762	Sliding	-	-	-
SKM-618	1800x600	B2 D1R	500x400x250	19094763	Sliding	-	19094770	Sliding
		B2 D1L	500x400x250	19094764	Sliding	-	19094771	Sliding
SKM-620	2000x600	B2 D2RL	500x400x250	19094765	Sliding	-	-	-

700 Range

MODEL	DIMENSIONS (mm)	BOWL DIMENSIONS (mm)	ELEMENTS WITH DOORS	DOOR TYPE	€	ELEMENTS WITH DOORS AND SPACE FOR UNDERCOUNTER DISHWASHER		€
						D	WD	
SKM-77	700x700	B1	500x500x300	19094772	Swing	-	-	-
SKM-710	1000x700	B1 D1R	400x500x300	19094773	Sliding	-	-	-
		B1 D1L	400x500x300	19094774	Sliding	-	-	-
		B2	400x500x300	19094775	Sliding	-	-	-
SKM-712	1200x700	B1 D1R	500x500x300	19094776	Sliding	-	19094789	Swing
		B1 D1L	500x500x300	19094777	Sliding	-	19094790	Swing
		B2	500x500x300	19094778	Sliding	-	-	-
SKM-714	1400x700	B1 D1R	600x500x300	19094779	Sliding	-	19094791	Swing
		B1 D1L	600x500x300	19094780	Sliding	-	19094792	Swing
		B2	600x500x300	19094781	Sliding	-	-	-
SKM-716	1600x700	B2 D1R	500x500x300	19094782	Sliding	-	-	-
		B2 D1L	500x500x300	19094783	Sliding	-	-	-
SKM-718	1800x700	B2 D1R	500x500x300	19094784	Sliding	-	19094793	Sliding
		B2 D1L	500x500x300	19094785	Sliding	-	19094794	Sliding
		B3	500x500x300	19094786	Sliding	-	-	-
SKM-720	2000x700	B2 D1R	600x500x300	19094787	Sliding	-	-	-
		B2 D1L	600x500x300	19094788	Sliding	-	-	-

Worktops

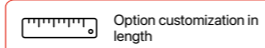

- Worktop made from AISI-304 18/10 stainless steel with satin finish.
- Backsplash of 100 x 15 mm and 50 mm front edge with

- welded corners.
- Designed to be mounted on neutral and hot element compositions without worktop.



Flat worktops

600 Range



DIMENSIONS (mm)	WALL-MOUNTED MTTW-6	€	CENTRAL MTTC-6	€
600x600	19094903	-	19094880	-
700x600	19094904	-	19094881	-
800x600	19094905	-	19094882	-
900x600	19094906	-	19094883	-
1000x600	19094907	-	19094884	-
1100x600	19094908	-	19094885	-
1200x600	19094909	-	19094886	-
1300x600	19094910	-	19094887	-
1400x600	19094911	-	19094888	-
1500x600	19094912	-	19094889	-
1600x600	19094913	-	19094890	-
1700x600	19094914	-	19094891	-
1800x600	19094915	-	19094892	-
1900x600	19094916	-	19094893	-
2000x600	19094917	-	19094894	-
2100x600	19094918	-	19094895	-
2200x600	19094919	-	19094896	-
2300x600	19094920	-	19094897	-
2400x600	19094921	-	19094898	-
2500x600	19094922	-	19094899	-
2600x600	19094923	-	19094900	-
2700x600	19094924	-	19094901	-
2800x600	19094925	-	19094902	-

700 Range



DIMENSIONS (mm)	WALL-MOUNTED MTTW-7	€	CENTRAL MTTC-7	€
600x700	19094949	-	19094926	-
700x700	19094950	-	19094927	-
800x700	19094951	-	19094928	-
900x700	19094952	-	19094929	-
1000x700	19094953	-	19094930	-
1100x700	19094954	-	19094931	-
1200x700	19094955	-	19094932	-
1300x700	19094956	-	19094933	-
1400x700	19094957	-	19094934	-
1500x700	19094958	-	19094935	-
1600x700	19094959	-	19094936	-
1700x700	19094960	-	19094937	-
1800x700	19094961	-	19094938	-
1900x700	19094962	-	19094939	-
2000x700	19094963	-	19094940	-
2100x700	19094964	-	19094941	-
2200x700	19094965	-	19094942	-
2300x700	19094966	-	19094943	-
2400x700	19094967	-	19094944	-
2500x700	19094968	-	19094945	-
2600x700	19094969	-	19094946	-
2700x700	19094970	-	19094947	-
2800x700	19094971	-	19094948	-

Double central flat worktop



1200 Range

MODEL	CODE	DIMENSIONS (mm)	€
MTTC-1214	19094795	1400x1200	-
MTTC-1216	19094796	1600x1200	-
MTTC-1218	19094797	1800x1200	-
MTTC-1220	19094798	2000x1200	-
MTTC-1222	19094799	2200x1200	-
MTTC-1224	19094800	2400x1200	-
MTTC-1226	19094801	2600x1200	-
MTTC-1228	19094802	2800x1200	-

1300 Range

MODEL	CODE	DIMENSIONS (mm)	€
MTTC-1314	19094803	1400x1300	-
MTTC-1316	19094804	1600x1300	-
MTTC-1318	19094805	1800x1300	-
MTTC-1320	19094806	2000x1300	-
MTTC-1322	19094807	2200x1300	-
MTTC-1324	19094808	2400x1300	-
MTTC-1326	19094809	2600x1300	-
MTTC-1328	19094810	2800x1300	-

Worktops with bowl

- Welded bowl of 500 x 400 x 250 mm.

600 Range



DIMENSIONS (mm)	BOWL TO THE RIGHT MTTW-B1R-6	€	BOWL TO THE LEFT MTTW-B1L-6	€	BOWL IN CENTER MTTW-B1C-6	€
1000x600	19094972	-	19094983	-	19094994	-
1200x600	19094973	-	19094984	-	19094995	-
1400x600	19094974	-	19094985	-	19094996	-
1500x600	19094975	-	19094986	-	19094997	-
1600x600	19094976	-	19094987	-	19094998	-
1800x600	19094977	-	19094988	-	19094999	-
2000x600	19094978	-	19094989	-	19095000	-
2200x600	19094979	-	19094990	-	19095001	-
2400x600	19094980	-	19094991	-	19095002	-
2600x600	19094981	-	19094992	-	19095003	-
2800x600	19094982	-	19094993	-	19095004	-

700 Range

DIMENSIONS (mm)	BOWL TO THE RIGHT MTTW-B1R-7	€	BOWL TO THE LEFT MTTW-B1L-7	€	BOWL IN CENTER MTTW-B1C-7	€
1000x700	19095005	-	19095016	-	19095027	-
1200x700	19095006	-	19095017	-	19095028	-
1400x700	19095007	-	19095018	-	19095029	-
1500x700	19095008	-	19095019	-	19095030	-
1600x700	19095009	-	19095020	-	19095031	-
1800x700	19095010	-	19095021	-	19095032	-
2000x700	19095011	-	19095022	-	19095033	-
2200x700	19095012	-	19095023	-	19095034	-
2400x700	19095013	-	19095024	-	19095035	-
2600x700	19095014	-	19095025	-	19095036	-
2800x700	19095015	-	19095026	-	19095037	-

Reinforced profile refrigerated tables

- Made from stainless steel.
- To be installed on refrigerated tables without countertop for alignment

in modular compositions.

MODEL	CODE	APPLIES TO	€
R-ACP	19095383	GN ACP refrigerated counters	-
R-CCP-G	19095384	GN CCP refrigerated counters	-
R-CCP-S	19095385	Snack CCP refrigerated counters	-

FOR REFRIGERATED COUNTERS LENGTH (mm)	QUANTITY
<2000	3
>=2000	4

Recycling station elements



See options

- Worktop made from AISI-304 18/10 stainless steel with satin finish.
- Backsplash of 100 x 15 mm and 50 mm front edge with welded corners.
- Element with closed structure made from stainless steel.
- 850 mm height elements with stainless steel height-adjustable feet (-10 mm / + 50 mm).

- Designed for the classification and collection of waste.
- Ø195 mm holes for placing rubber rings.
- Rubber ring (not included) to throw waste. A waste bin (not included) with maximum diameter of 360 mm could be placed under the counter.
- Supplied assembled.



Mural

MODEL	CODE	DIMENSIONS (mm)	HOLES	€
ADULTS				
TMW-R-612	19094813	1200x600x850	2	-
TMW-R-618	19094814	1800x600x850	3	-
KIDS  kids				
TMW-R-K-612	19094817	1200x600x700	2	-
TMW-R-K-618	19094818	1800x600x700	3	-

Central

MODEL	CODE	DIMENSIONS (mm)	HOLES	€
ADULTS				
TMC-R-612	19094811	1200x600x850	2	-
TMC-R-618	19094812	1800x600x850	3	-
KIDS  kids				
TMC-R-K-612	19094815	1200x600x700	2	-
TMC-R-K-618	19094816	1800x600x700	3	-



Rubber ring

- Removable internal Ø162 mm rubber ring that facilitates the identification of the container.
- Easy to clean and disinfect.

MODEL	CODE	COLOR	€
R-Y232	19092787	Yellow	-
R-B232	19092788	Blue	-
R-R232	19092789	Red	-
R-G232	19092790	Green	-

Accessories

Sorting hole lid

- Specially designed to be placed on the sorting hole to cover it.



MODEL	CODE	€
RL-232	19092820	-

Castors kit

- Ø125 mm castors.



MODEL	CODE	No. CASTORS	TABLE LENGTH	€
CMK-4	19092830	4	<= 2000 mm	-
CMK-5	19092831	5	Closed corner elements	-
CMK-6	19092832	6	> 2000 mm	-

Plinths

- Made from stainless steel and easy assembling.

For modular neutral and hot elements

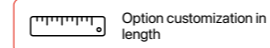

MODEL	CODE	DIMENSIONS (mm)	€
PF-4	19094819	400	-
PF-5	19094820	500	-
PF-6	19094821	600	-
PF-8	19094822	800	-
PF-10	19094823	1000	-
PF-12	19094824	1200	-
PF-14	19094825	1400	-
PF-16	19094826	1600	-
PF-18	19094827	1800	-
PF-20	19094828	2000	-
PF-22	19092779	2200	-
PF-24	19095040	2400	-
SF-6	19092843	600 mm side	-
SF-7	19092844	700 mm side	-
PF-90WD	19095380	Closed corner elements	-
PF-90W	19095381	Corner elements with door - right or left worktop	-

For refrigerated counters Concept

MODEL	CODE	APPLIES TO	€
PF-CC-2G	19092833	Concept GN 2-door refrigerated counters	-
PF-CC-3G	19092834	Concept GN 3-door refrigerated counters	-
PF-CC-4G	19092835	Concept GN 4-door refrigerated counters	-
PF-CC-2G R	19092836	Concept GN 2-door remote refrigerated counters	-
PF-CC-3G R	19092837	Concept GN 3-door remote refrigerated counters	-
PF-CC-4G R	19092838	Concept GN 4-door remote refrigerated counters	-
PF-CC-2S	19107247	Concept Snack 2-door refrigerated counters	-
PF-CC-3S	19092839	Concept Snack 3-door refrigerated counters	-
PF-CC-4S	19092840	Concept Snack 4-door refrigerated counters	-
PF-CC-2S R	19092841	Concept Snack 2-door remote refrigerated counters	-
PF-CC-3S R	19092842	Concept Snack 3-door remote refrigerated counters	-
PF-CC-4S R	19107248	Concept Snack 4-door remote refrigerated counters	-
SF-G	19107249	Side plinth for Concept GN refrigerated counters	-
SF-S	19107251	Side plinth for Concept Snack refrigerated counters	-

For refrigerated counters Advance

MODEL	CODE	APPLIES TO	€
PF-AC-2G	19095562	Advance GN 2-door refrigerated counters	-
PF-AC-3G	19095563	Advance GN 3-door refrigerated counters	-
PF-AC-4G	19095564	Advance GN 4-door refrigerated counters	-
SF-A	19107252	Side plinth for Advance GN refrigerated counters	-

Options

Option customization in length



Indicate the code and price of the next higher model and the desired length.

Option 1.5 mm thickness worktop.

ABBREVIATION	CODE	DIMENSIONS (mm)	€
1,5	0204-0001	Up to 1200 mm	-
1,5	0204-0002	Up to 2000 mm	-
1,5	0204-0003	Up to 2800 mm	-

Option stainless steel reinforcements with profile.

DIMENSIONS (mm)	ABBREVIATION	WORKTOPS	€	ABBREVIATION	ONE (1) SHELF	€	ABBREVIATION	WORKTOP AND ONE (1) SHELF	€	ABBREVIATION	WORKTOP AND TWO (2) SHELVES	€
Up to 1200 mm	ST	0205-0001	-	SS	0205-0006	-	STS	0205-0011	-	ST2S	0205-0016	-
Up to 1600 mm	ST	0205-0002	-	SS	0205-0007	-	STS	0205-0012	-	ST2S	0205-0017	-
Up to 2000 mm	ST	0205-0003	-	SS	0205-0008	-	STS	0205-0013	-	ST2S	0205-0018	-
Up to 2400 mm	ST	0205-0004	-	SS	0205-0009	-	STS	0205-0014	-	ST2S	0205-0019	-

Option door lock.

ABBREVIATION	CODE	DESCRIPTION	€
CR	0206-0001	One (1) lock	-
CR	0206-0002	Two (2) locks	-
CR	0206-0004	Four (4) locks	-

Option side splash folded and welded to the worktop.

ABBREVIATION	CODE	SIDE	€
SPR	0207-0001	Right	-
SPL	0207-0002	Left	-
SPRL	0207-0003 *	Right + Left	-

* Maximum length up to 2600 mm.

Option faucet hole Ø 33 mm.

ABBREVIATION	CODE	DESCRIPTION	€
33R1	0208-0001	One (1) hole to the right	-
33L1	0208-0002	One (1) hole to the left	-
33C1	0208-0003	One (1) hole centered	-
33B1	0208-0004	One (1) hole between two (2) bowls	-
33R2	0208-0005	Two (2) holes to the right	-
33L2	0208-0006	Two (2) holes to the left	-
33C2	0208-0007	Two (2) holes centered	-
33B2	0208-0008	Two (2) holes between three (3) bowls	-
33R3	0208-0009	Three (3) holes to the right	-
33L3	0208-0010	Three (3) holes to the left	-
33C3	0208-0011	Three (3) holes centered	-

Option one (1) sorting hole with black rubber ring on the worktop to throw waste.

ABBREVIATION	CODE	DESCRIPTION	€
RC	0209-0003	One (1) hole with ring centered	-
R	0209-0006	One (1) custom hole with ring	-

Composition examples

Wall-mounted corner composition with integrated refrigerated counter:



No	MODEL	CODE	DESCRIPTION	DIMENSIONS (mm)	QUANTITY
1	MTTW-726	19094969	Wall-mounted flat worktop	2600x700	1
2	TMDR3-74 SE	19094490	Element with 3 drawers without worktop	400x700x850	1
3	TMHD-76 SE	19094521	Elements with swing doors without worktop	600x700x850	1
4	TM-74 GN SE	19094641	Element with rack module 1xGN1/1 without worktop	400x700x850	1
5	TMS1-712 SE	19094406	Element with shelves without worktop	1200x700x850	1
6	TM90WD-7	19094626	Corner element with door	1000x1000x700x850	1
7	MTTW-B1R-724	19095013	Worktop with bowl to the right	2400x700	1
	33C1	0208-0003	One (1) centered faucet hole Ø 33 mm		
8	CCP-2G NT	19089829	Concept GN 2-door refrigerated counters without worktop	1342x700x850	1
9	R-CCP-G	19095384	Reinforcement with profiles for Concept refrigerated counters	-	3
10	TMHD-710 OB SE	19094526	Elements with swing doors for worktops with bowl	1000x700x850	1

Double central composition with integrated hot element:



No	MODEL	CODE	DESCRIPTION	DIMENSIONS (mm)	QUANTITY
1	MTTC-1326	19094809	Double central flat worktop	2600x1300	1
2	TMS1-68 SE	19094374	Element with shelves without worktop	800x600x850	1
3	TMD-612 SE	19094450	Elements with sliding doors without worktop	1200x600x850	1
4	TMDR1-66 SE	19094493	Element with large capacity drawer without worktop	600x600x850	1
5	TMHD-74 SE	19094520	Elements with swing doors without worktop	400x700x850	1
6	TM-710 P SE	19094644	Element with rack module 2x600x400 without worktop	1000x700x850	1
7	TMH-712 SE	19094658	Hot element without worktop	1200x700x850	1
8	PF-8	19094822	Plinth	800	1
9	PF-12	19094824	Plinth	1200	2
10	PF-6	19094821	Plinth	600	1
11	PF-4	19094819	Plinth	400	1
12	PF-10	19094823	Plinth	1000	1
13	SF-6	19092843	Side plinth	600	2
14	SF-7	19092844	Side plinth	700	2

Wall-mounted corner composition with integrated hot element:



No	MODEL	CODE	DESCRIPTION	DIMENSIONS (mm)	QUANTITY
1	MTTW-723	19094966	Wall-mounted flat worktop	2300x700x850	1
	R	0209-0006	One (1) custom hole		1
2	TMD-712 SE	19094474	Elements with sliding doors without worktop	1200x700x850	1
3	TMD-R-76 SE	19094620	Waste collection elements without worktop	600x700x850	1
4	TM90W-7 R	19094623	Closed corner elements - right worktop	1200x700x850	1
5	TMWH-720	19094689	Hot element	2000x700x850	1

Bar elements

Coffee back bar counters	493
— Coffee back bar counters	493
— Back bar counters	493
Cocktail stations.....	494
— Accessories	496
Options	496

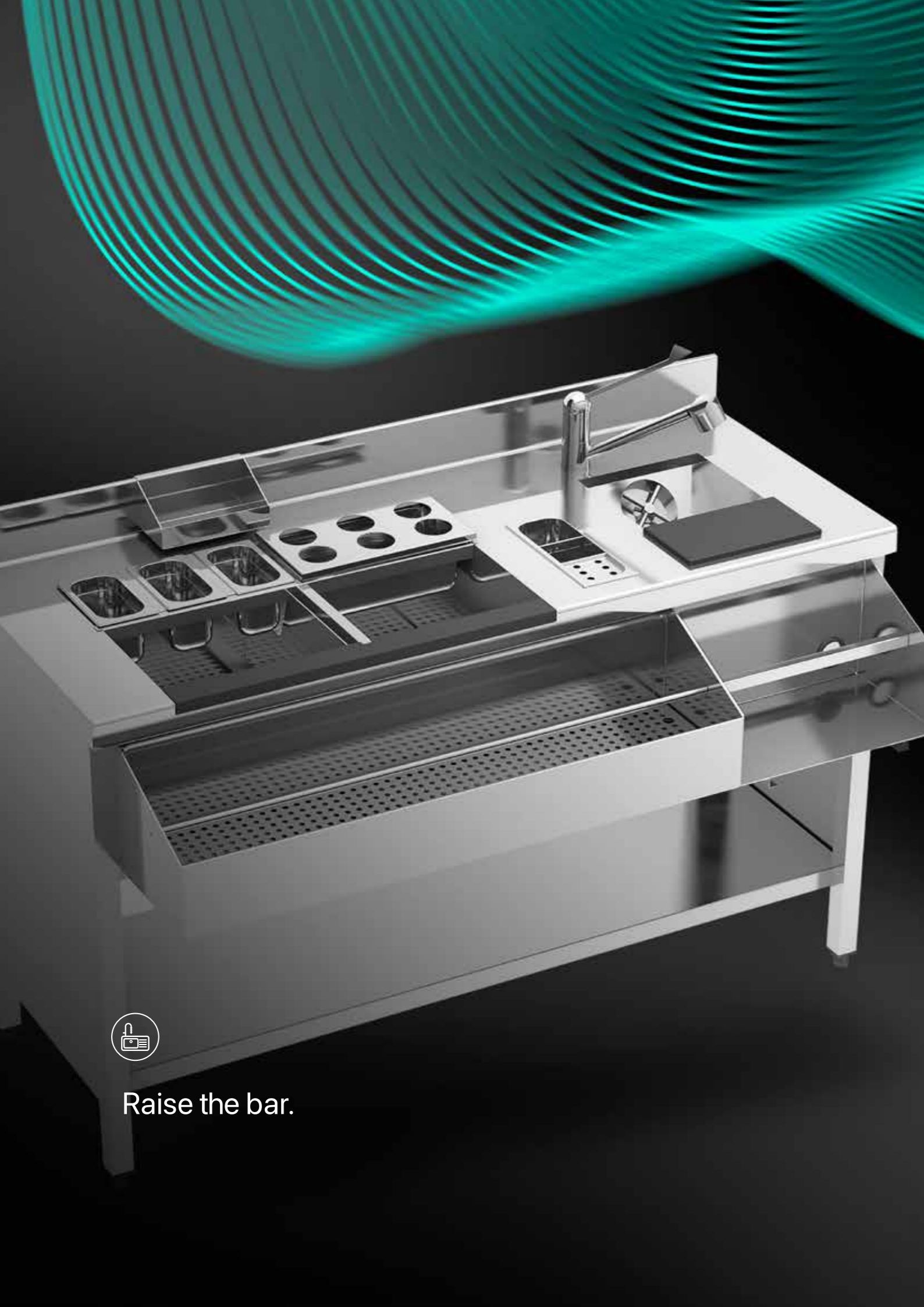

Raise the bar.

Coffee back bar counters



TFS1-615 WH



See options

- Specially designed to place a coffee machine. Ideal for coffee shops, bars or restaurants.
- To be complemented with back and refrigerated counters, to set up a bar line adapted to each space and need.
- Removable drawers with telescopic sliding guides.
- Waste hopper to collect coffee grounds, with a rubber stopper that absorbs noise when using.
- Back in stainless steel, partially open for coffee machine installation.
- Worktop made from AISI-304 18/10 stainless steel with satin finish and reinforced with profiles.
- Backsplash of 100 x 15 mm, 50 mm front edge with welded corners.
- Supplied assembled.

DIMENSIONS (mm)	HOPPER POSITION	MODEL	NO HOLE ON WORKTOP	€	MODEL	WITH HOLE ON WORKTOP	€	MODEL	WITHOUT WORKTOP	€
1000x600x1050	Right	TFS1-610 R	19094266	-	TFS1-610 R WH	19094267	-	TFS1-610 R SE	19094268	-
1000x600x1050	Left	TFS1-610 L	19094269	-	TFS1-610 L WH	19094270	-	TFS1-610 L SE	19094271	-
1500x600x1050	Center	TFS1-615	19094272	-	TFS1-615 WH	19094273	-	TFS1-615 SE	19094274	-
2000x600x1050	Center	TFS1-620	19094275	-	TFS1-620 WH	19094276	-	TFS1-620 SE	19094277	-
2500x600x1050	Center	TFS1-625	19094278	-	TFS1-625 WH	19094279	-	TFS1-625 SE	19094280	-

Back bar counters

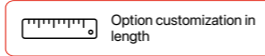

Option customization in length

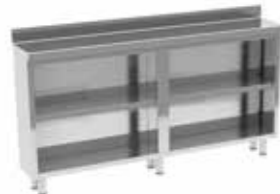

TBBS1-315



See options

- Specially designed to store small machinery, kitchenware, bar accessories, etc. Ideal for coffee shops, bars or restaurants.
- To be complemented with coffee and refrigerated back counters, to set up a bar line adapted to each space and need.
- Worktop made from AISI-304 18/10 stainless steel with satin finish and reinforced with profiles.
- Backsplash of 100 x 15 mm, 50 mm front edge with welded corners.
- Supplied assembled.

350 Range

DIMENSIONS (mm)	WITH ONE (1) SHELF		WITH TWO (2) SHELVES	
	WITH WORKTOP	WITHOUT WORKTOP	WITH WORKTOP	WITHOUT WORKTOP
	TBBS1-3	TBBS1-3 SE	TBBS2-3	TBBS2-3 SE
1000x350x1050	19094281	19094285	19094289	19094293
1500x350x1050	19094282	19094286	19094290	19094294
2000x350x1050	19094283	19094287	19094291	19094295
2500x350x1050	19094284	19094288	19094292	19094296

600 Range

DIMENSIONS (mm)	WITH ONE (1) SHELF		WITH TWO (2) SHELVES	
	WITH WORKTOP	WITHOUT WORKTOP	WITH WORKTOP	WITHOUT WORKTOP
	TBBS1-6	TBBS1-6 SE	TBBS2-6	TBBS2-6 SE
1000x600x1050	19094297	19094301	19094305	19094309
1500x600x1050	19094298	19094302	19094306	19094310
2000x600x1050	19094299	19094303	19094307	19094311
2500x600x1050	19094300	19094304	19094308	19094312

Single cocktail stations



CKS1-12 BR1



See options

Table with ice well

- Worktop made from AISI-304 18/10 stainless steel with satin finish.
- Well with thermal insulation and built-in drain.
- Backsplash of 100 x 15 mm, 50 mm front edge with welded corners.
- Square section stainless steel legs 40 x 40 mm.
- Rear legs set back 40 mm for floors with sanitary radius.
- Model with reinforcement frame: three (3) crossbars, two (2) at the sides and one (1) at the rear, as lower part element reinforcement. There is the possibility of placing the crossbar in a central position.
- Model with shelf: shelf made from stainless steel with satin finish and reinforcements in profile. Shelf assembly done by fixing four (4) screws.
- 900 mm height with stainless steel height-adjustable feet (-10 mm / +50 mm).
- Supplied assembled.

MODEL	CODE	DIMENSIONS (mm)	TYPE	SPEED RAIL	BLENDER HOLDER	€
CKLR-12 BR1	19094866	1200x610x900	Reinforcement frame	Single	No	-
CKS1-12 BR1	19094867	1200x610x900	With shelf	Single	No	-

Table with ice well and sink



CKS1-S-12 BR2 BS

- Worktop made from AISI-304 18/10 stainless steel with satin finish.
- Well with thermal insulation and built-in drain.
- 275x250x150 mm sink with built-in drain.
- Single lever mixer faucet included.
- Backsplash of 100 x 15 mm, 50 mm front edge with welded corners.
- Square section stainless steel legs 40 x 40 mm.
- Rear legs set back 40 mm for floors with sanitary radius.
- Model with reinforcement frame: three (3) crossbars, two (2) at the sides and one (1) at the rear, as lower part element reinforcement. There is the possibility of placing the crossbar in a central position.
- Model with shelf: shelf made from stainless steel with satin finish and reinforcements in profile. Shelf assembly done by fixing four (4) screws.
- 900 mm height with stainless steel height-adjustable feet (-10 mm / +50mm).
- Supplied assembled.

MODEL	CODE	DIMENSIONS (mm)	TYPE	SPEED RAIL	BLENDER HOLDER	€
CKLR-S-12 BR1	19094869	1200x610x900	Reinforcement frame	Single	No	-
CKS1-S-12 BR1	19094870	1200x610x900	With shelf	Single	No	-
CKLR-S-12 BR1 BS	19107493	1200x720x900	Reinforcement frame	Single	Yes	-
CKS1-S-12 BR1 BS	19107490	1200x720x900	With shelf	Single	Yes	-
CKLR-S-12 BR2 BS	19094872	1200x720x900	Reinforcement frame	Double	Yes	-
CKS1-S-12 BR2 BS	19094871	1200x720x900	With shelf	Double	Yes	-
CKLR-S-15 BR1 BS	19107495	1500x720x900	Reinforcement frame	Single	Yes	-
CKS1-S-15 BR1 BS	19107494	1500x720x900	With shelf	Single	Yes	-
CKLR-S-15 BR2 BS	19094874	1500x720x900	Reinforcement frame	Double	Yes	-
CKS1-S-15 BR2 BS	19094873	1500x720x900	With shelf	Double	Yes	-



CKM-S-DW-15 BR2 BS

Element with ice well and sink

- Worktop made from AISI-304 18/10 stainless steel with satin finish.
- Well with thermal insulation and built-in drain.
- 275x250x150 mm sink with built-in drain.
- Single lever mixer faucet included.
- Backsplash of 100 x 15 mm, 50 mm front edge with welded corners.
- Element with closed structure made from stainless steel.
- Lower base reinforced with profile to guarantee greater robustness.
- 900 mm height with stainless steel height-adjustable feet (-10 mm / + 50 mm).
- Supplied assembled.

MODEL	CODE	DIMENSIONS (mm)	SPEED RAIL	BLENDER HOLDER	DIPPER WELL	€
CKM-S-DW-15 BR2 BS	19094878	1500x720x900	Double	Yes	Yes	-



CKRF-S-DW-15 BR2 BS

Element with ice well, sink and refrigerated reserve

- Worktop made from AISI-304 18/10 stainless steel with satin finish.
- Well with thermal insulation and built-in drain.
- 275x250x150 mm sink with built-in drain.
- Single lever mixer faucet included.
- Backsplash of 100 x 15 mm, 50 mm front edge with welded corners.
- Rear legs set back 40 mm for floors with sanitary radius.
- Refrigerated reserve with drawers at the bottom, designed to store bottles.
- Stainless steel removable refrigerated drawers, with telescopic sliding guides and self-closing system.
- Rod modular system allowing an optimal organization of bottles in drawers.
- High-density (40 kg/m³), CFC-free, ecological polyurethane insulation.
- Removable pull-out/push-in magnetic gasket to keep maximum hygiene and maintain the insulating properties.
- Easy-to-extract condensing unit included.
- Evaporation system of defrost water with evaporation pan.
- Electrical components in a single, easy-to-access point to enable maintenance operations.
- Stainless steel ventilation grills on the customer side.
- Forced draft evaporator.
- Electronic thermostat, with digital display, to control and regulate the temperature of the refrigerated reserve.
- Working temperature (in climate Class IV conditions): from +0 °C to +4 °C.
- Supplied assembled.

MODEL	REFRIGERANT GAS	HZ	CODE	DIMENSIONS (mm)	SPEED RAIL	BLENDER HOLDER	DIPPER WELL	POWER (W)	€
CKRF-S-15 BR2 BS	R290	50/60	19094877	1500x720x900	Double	Yes	No	255	-
CKRF-S-DW-15 BR2 BS	R290	50/60	19094879	1500x720x900	Double	Yes	Yes	255	-

Accessories



Jigger shelf

- Specially designed to store jiggers. It can be hung from the backsplash or from the cocktail station well.

MODEL	CODE	€
SS-3	19092975	-



Bottle support

- Specially designed to store bottles inside a GN 1/3 pan (not included).

MODEL	CODE	€
SB-13	19092976	-

Options

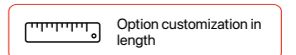

Option customization in length

Indicate the code and price of the next higher model and the desired length.

Option 1.5 mm thickness worktop.

ABBREVIATION	CODE	DIMENSIONS (mm)	€
1,5	0204-0001	Up to 1200 mm	-
1,5	0204-0002	Up to 2000 mm	-
1,5	0204-0003	Up to 2800 mm	-

Note: applies to back bar elements.

Option side splash folded and welded to the worktop.

ABBREVIATION	CODE	SIDE	€
SPR	0207-0001	Right	-
SPL	0207-0002	Left	-
SPRL	0207-0003	Right + left	-

Note: applies to back bar elements.

Option stainless steel reinforcements with profile.

DIMENSIONS (mm)	ABBREVIATION ONE (1) SHELF	CODE	€	ABBREVIATION WORKTOP AND ONE (1) SHELF	CODE	€
Up to 1200 mm	SS	0205-0006	-	STS	0205-0011	-
Up to 1600 mm	SS	0205-0007	-	STS	0205-0012	-
Up to 2000 mm	SS	0205-0008	-	STS	0205-0013	-
Up to 2800 mm	SS	0205-0010	-	STS	0205-0015	-

Shelving

Wall-mounted shelves.....	499
Shelves on racks.....	502
Polyethylene shelves.....	503



Stability, strength and maximized storage space utilization.

Wall-mounted shelves



Welded flat shelves

- Made from stainless steel fully welded.
- Wall brackets with drills (screws and plugs included).

 Option customization in length

MODEL	CODE	DIMENSIONS (mm)	€
SW-26	19094831	600x250x150	-
SW-28	19094832	800x250x150	-
SW-210	19094833	1000x250x150	-
SW-212	19094834	1200x250x150	-
SW-214	19094835	1400x250x150	-
SW-215	19094836	1500x250x150	-
SW-216	19094837	1600x250x150	-
SW-218	19094838	1800x250x150	-
SW-220	19094839	2000x250x150	-
SW-46	19094840	600x400x250	-
SW-48	19094841	800x400x250	-
SW-410	19094842	1000x400x250	-
SW-412	19094843	1200x400x250	-
SW-414	19094844	1400x400x250	-
SW-415	19094845	1500x400x250	-
SW-416	19094846	1600x400x250	-
SW-418	19094847	1800x400x250	-
SW-420	19094848	2000x400x250	-

Flat shelves with brackets

- Made from stainless steel.
- Wall brackets with drills (screws and plugs included).
- Quick and easy assembly.

 Option customization in length



MODEL	CODE	DIMENSIONS (mm)	€
SWD-36	19094857	600x300x200	-
SWD-38	19094858	800x300x200	-
SWD-310	19094859	1000x300x200	-
SWD-312	19094860	1200x300x200	-
SWD-314	19094861	1400x300x200	-
SWD-315	19094862	1500x300x200	-
SWD-316	19094863	1600x300x200	-
SWD-318	19094864	1800x300x200	-
SWD-320	19094865	2000x300x200	-

Dish drainer shelves



- Made from stainless steel fully welded.
- Removable stainless steel grills for easy cleaning.
- Wall brackets with drills (screws and plugs included).
- For plates with a maximum diameter of 250 mm.

MODEL	CODE	DIMENSIONS (mm)	€
SD-37	19092876	780x300x200	-
SD-314	19092877	1535x300x200	-

Extraction hood shelves

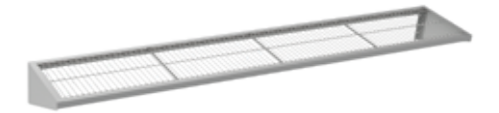

- Made from stainless steel fully welded.
- Removable GN 1/1 stainless steel grills for easy cleaning.
- Wall brackets with drills (screws and plugs included).

MODEL	CODE	DIMENSIONS (mm)	€
SH-45	19092878	595x390x200	-
SH-411	19092879	1125x390x200	-
SH-416	19092880	1655x390x200	-
SH-421	19092881	2185x390x200	-

 Option customization in length

Microwave shelves



- Specially designed to place a microwave oven or other small appliances.
- Made from stainless steel.
- Wall brackets with drills (screws and plugs included).
- Ø60 mm cable gland hole.
- Quick and easy assembly.
- Supplied disassembled.

MODEL	CODE	DIMENSIONS (mm)	€
SMW-46	19092882	600x400x230	-
SMW-57	19092883	700x550x280	-
SMW-48	19092884	800x400x230	-

Tube shelves



- Made from stainless steel fully welded.
- Wall brackets with drills (screws and plugs included).
- The 1800 and 2000mm long models have a welded center bracket.

MODEL	CODE	DIMENSIONS (mm)	€
SP-46	19094849	600x400x250	-
SP-48	19094850	800x400x250	-
SP-410	19094851	1000x400x250	-
SP-412	19094852	1200x400x250	-
SP-414	19094853	1400x400x250	-
SP-416	19094854	1600x400x250	-
SP-418	19094855	1800x400x250	-
SP-420	19094856	2000x400x250	-

Dishwashing basket tilted shelves

- Made from stainless steel fully welded.
- Wall brackets with drills (screws and plugs included).
- Ø16 mm drain.



MODEL	CODE	DIMENSIONS (mm)	€
SWW-511	19092901	1100x505x231	-
SWW-516	19092902	1600x505x231	-

Wall-mounted shelves on racks

- Made from stainless steel.



Vertical rack

MODEL	CODE	DIMENSIONS (mm)	€/UNIT
SAS-6	19092885	600	-
SAS-10	19092886	1000	-
SAS-15	19092887	1500	-

Flat shelf

MODEL	CODE	DIMENSIONS (mm)	€
SPF-210	19092888	1000x250	-
SPF-212	19092889	1200x250	-
SPF-214	19092890	1400x250	-
SPF-216	19092891	1600x250	-
SPF-410	19092892	1000x400	-
SPF-412	19092893	1200x400	-
SPF-414	19092894	1400x400	-
SPF-416	19092895	1600x400	-

Tilted shelf

MODEL	CODE	DIMENSIONS (mm)	No PANS	PANS SIZE	€
SI-210	19092896	1000x250	4	GN 1/6	-
SI-410	19092897	1000x400	4	GN 1/3	-



Hanging bar

- Made from stainless steel fully welded.
- Ø30 mm tube.
- Welded plates with drills (screws and plugs included).

MODEL	CODE	DIMENSIONS (mm)	€
UH-10	19092898	1000x150	-
UH-15	19092899	1500x150	-
UH-20	19092900	2000x150	-

Shelves on racks



On racks

- Made from stainless steel.
- Height of the shelves adjustable every 150 mm.

MODEL	CODE	DIMENSIONS (mm)	€/SET 4 FEET
SF-17	19092935	1700	-
SF-20	19092936	2000	-

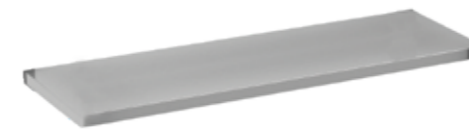

Stainless steel flat shelves

- Made from stainless steel.
- Shelves fixed to the racks using tools included.

DIMENSIONS (mm)	1 mm THICKNESS						1.5 mm THICKNESS					
	WITHOUT REINFORCEMENT		MAXIMUM LOAD (KG)/SHELF	€	WITH REINFORCEMENT		MAXIMUM LOAD (KG)/SHELF	€	WITHOUT REINFORCEMENT		MAXIMUM LOAD (KG)/SHELF	€
	SS10	SS10R			SS15	SS15R						
800x400	19092903	210	-	19092911	260	-	19092919	280	-	19092927	330	-
1000x400	19092904	160	-	19092912	210	-	19092920	230	-	19092928	280	-
1200x400	19092905	110	-	19092913	160	-	19092921	130	-	19092929	180	-
1400x400	19092906	85	-	19092914	135	-	19092922	105	-	19092930	155	-
800x500	19092907	205	-	19092915	255	-	19092923	280	-	19092931	330	-
1000x500	19092908	155	-	19092916	205	-	19092924	230	-	19092932	280	-
1200x500	19092909	105	-	19092917	155	-	19092925	130	-	19092933	180	-
1400x500	19092910	80	-	19092918	130	-	19092926	105	-	19092934	155	-



Polyethylene shelves

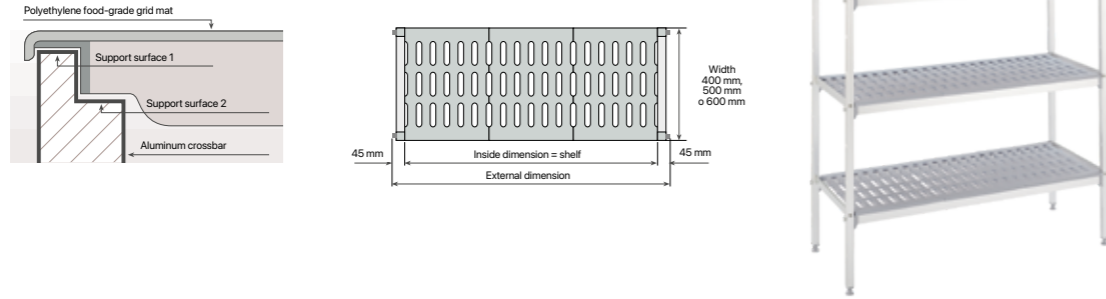

- Shelving with structure in anodized aluminum and polyethylene food-grade grid mats specially designed to be used in cold rooms.
- Polyethylene shelf plates are supported on two edges of the aluminum upright, for a perfect placement and greater solidity.
- Width options in shelf plates: 400, 500 and 600 mm.
- Standard height of uprights is 1.750 mm. 2.000 are also available for non-standard applications.

Aluminum and polyethylene shelves



- Food-grade aluminum and polyethylene shelf specially designed to be used in cold rooms, in accordance with sanitary requirements.
- Supported on the aluminum upright by two edges,
- for a perfect placement and greater solidity.
- Easily removable. Can be washed in a conventional dishwasher.
- Grid mats and crossbars included.

Width 400 mm

MODEL	CODE	DIMENSIONS (mm)	€
SA-46	19091192	600x400	-
SA-47	19091196	700x400	-
SA-48	19091197	800x400	-
SA-49	19091198	900x400	-
SA-410	19091199	1000x400	-
SA-411	19091350	1100x400	-
SA-412	19091351	1200x400	-
SA-413	19091352	1300x400	-
SA-414	19091353	1400x400	-
SA-415	19091354	1500x400	-
SA-416	19091355	1600x400	-

Width 500 mm

MODEL	CODE	DIMENSIONS (mm)	€
SA-56	19091356	600x500	-
SA-57	19091358	700x500	-
SA-58	19091359	800x500	-
SA-59	19091360	900x500	-
SA-510	19091361	1000x500	-
SA-511	19091362	1100x500	-
SA-512	19091363	1200x500	-
SA-513	19091365	1300x500	-
SA-514	19091366	1400x500	-
SA-515	19091367	1500x500	-
SA-516	19091368	1600x500	-

Width 600 mm

MODEL	CODE	DIMENSIONS (mm)	€
SA-66	19106115	600x600	-
SA-67	19106116	700x600	-
SA-68	19106117	800x600	-
SA-69	19106118	900x600	-
SA-610	19106119	1000x600	-
SA-611	19106160	1100x600	-
SA-612	19106161	1200x600	-
SA-613	19106162	1300x600	-
SA-614	19106163	1400x600	-
SA-615	19106164	1500x600	-
SA-616	19106165	1600x600	-

Aluminum shelving uprights

- Made from anodized aluminum.
- Holes every 150 mm, to modify the size of standard models or increase the number of shelves
- by means of pins (4 per shelf).
- Height-adjustable feet to overcome unevenness on the floors.
- Pins included.

External dimensions of independent shelving units, including an upright on each side.

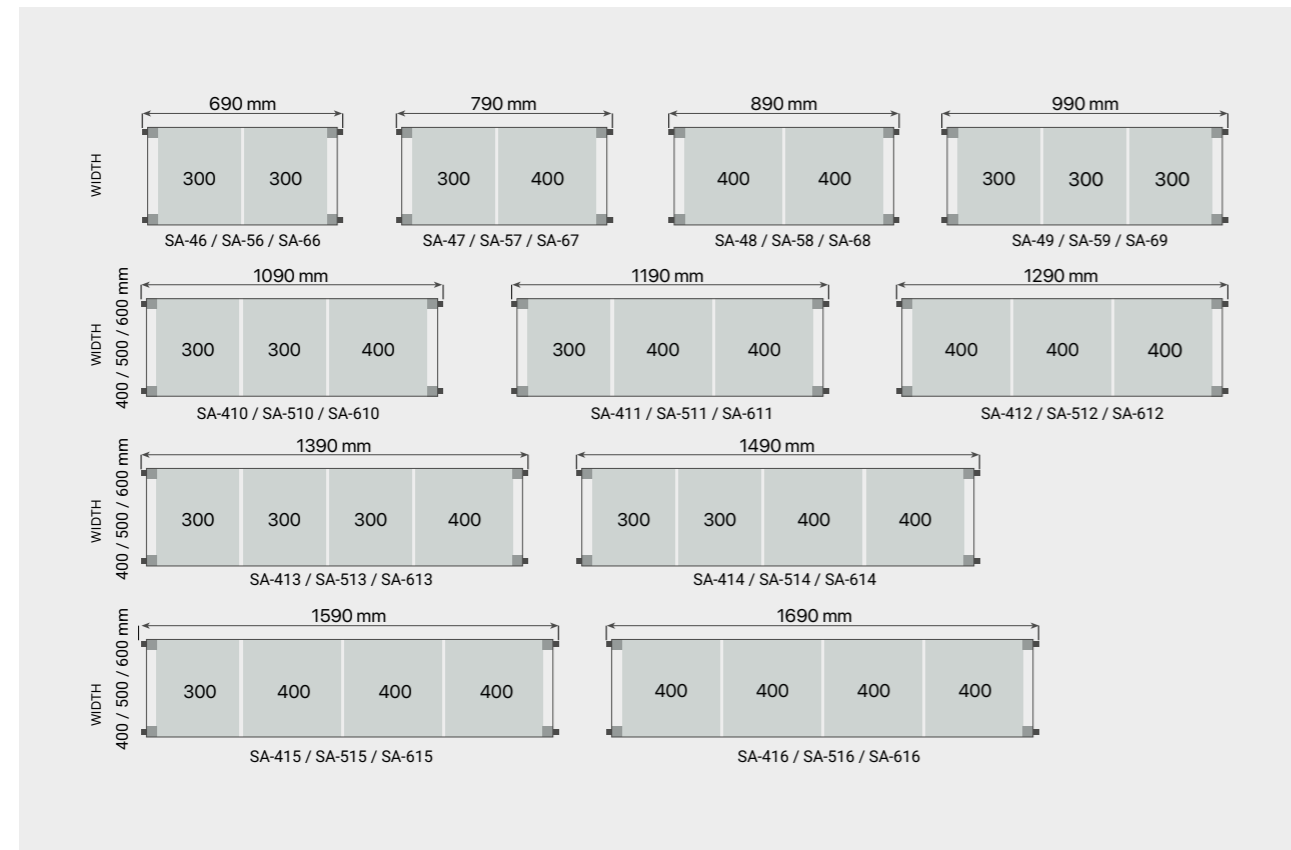

The 11 different lengths of the shelves allow, in addition to independent mounting with 2 uprights, multiple combinations by placing shelves on both sides of the uprights. See set tables.



MODEL	CODE	DIMENSIONS (mm)	LEVELS	€
WIDTH 400 mm				
AF17-43	19091369	1750x400	3	-
AF17-44	19091370	1750x400	4	-
AF17-45	19091371	1750x400	5	-
AF20-45	19091372	2000x400	5	-
AF20-46	19091373	2000x400	6	-
WIDTH 500 mm				
AF17-53	19091374	1750x500	3	-
AF17-54	19091375	1750x500	4	-
AF17-55	19091376	1750x500	5	-
AF20-55	19091377	2000x500	5	-
AF20-56	19091378	2000x500	6	-
WIDTH 600 mm				
AF17-63	19106166	1750x600	3	-
AF17-64	19106167	1750x600	4	-
AF17-65	19106168	1750x600	5	-
AF20-65	19106169	2000x600	5	-
AF20-66	19106170	2000x600	6	-

Mobile shelving uprights

- Two (2) Ø125 mm stainless polyamide castors, one (1) with brake. To build a mobile shelving, apart from the shelves, two (2) mobile uprights are needed.
- Uprights included only. Shelves must be ordered separately.



MODEL	CODE	DIMENSIONS (mm)	LEVELS	€
WIDTH 400 mm				
KMA17-44	19091380	1750x400	4	-
KMA17-45	19091381	1750x400	5	-
WIDTH 500 mm				
KMA17-54	19091382	1750x500	4	-
KMA17-55	19091383	1750x500	5	-
WIDTH 600 mm				
KMA17-64	19106171	1750x600	4	-
KMA17-65	19106172	1750x600	5	-



Benches

- Specially designed to store boxes in cold rooms.
- Robust stainless steel structure.

MODEL	CODE	DIMENSIONS (mm)	€
KSA2-1-510	19091391	1085x500x250	-
KSA2-1-512	19091392	1285x500x250	-
KSA2-1-516	19091393	1685x500x250	-



Grid mats

- Food-grade polyethylene grid mat for shelves.
- Easy to install. Can be washed in a conventional dishwasher.
- Complete shelves already include grid mats. Can be supplied as accessories.

MODEL	CODE	DIMENSIONS (mm)	€
SP-43	19091384	300x400	-
SP-44	19091385	400x400	-
SP-53	19091386	300x500	-
SP-54	19091388	400x500	-
SP-63	19106173	300x600	-
SP-64	19106174	400x600	-

Corner hooks

- Designed to make easier the assembly of corner-shaped shelving units. They also save shelving uprights and optimize the available space.
- Two (2) hooks per shelf.
- Price by unit.



MODEL	CODE	€
HK	19091389	-

Pins

- Designed to expand the number of shelves in standard configurations.
- pins for each shelf. Four (4) pins are required per shelf.
- Supplied as an accessory, since the uprights already include
- Price by unit.



MODEL	CODE	€
AS	19091390	-

Crossbars

- Supplied as an accessory, since they are included in each shelf.

MODEL	CODE	DIMENSIONS (mm)	€
CA-6	19091394	600	-
CA-7	19091395	700	-
CA-8	19091396	800	-
CA-9	19091397	900	-
CA-10	19091398	1000	-
CA-11	19091399	1100	-
CA-12	19091400	1200	-
CA-13	19091401	1300	-
CA-14	19091402	1400	-
CA-15	19091403	1500	-
CA-16	19091404	1600	-

Shelving sets calculation

How to order shelving sets

For your convenience, aluminum and polyethylene shelving can be ordered in sets. Below is an indication on how to calculate the required shelving set:

Is it a linear or corner shaped shelving unit?

- Linear shelving have uprights at each end.
- Corner shelving units have a upright at one end and, at the other end, they are supplied with two hooks per shelf, to be supported by the crossbars of another shelving unit.

What is the width of the shelving unit?

- There are two depth measurements: 400 or 500 mm.

How many levels are required?

- There are standard sets with 3, 4 or 5 levels.
- Additional levels can be ordered.

What will be the length of the shelving unit?

- In the tables on the following pages you should find the correct set for the measurements of the room where the shelving is to be placed.
- When calculating the length of the corner shelving unit, remember to subtract from the total length the depth of the shelving unit on which it will rest.

In the following example you would have to ask:

- Set number 99 (linear, depth 400 mm, 4 levels, 1690 mm long).
- Set number 582 (angle, depth 400 mm, 4 levels, 952 mm long).

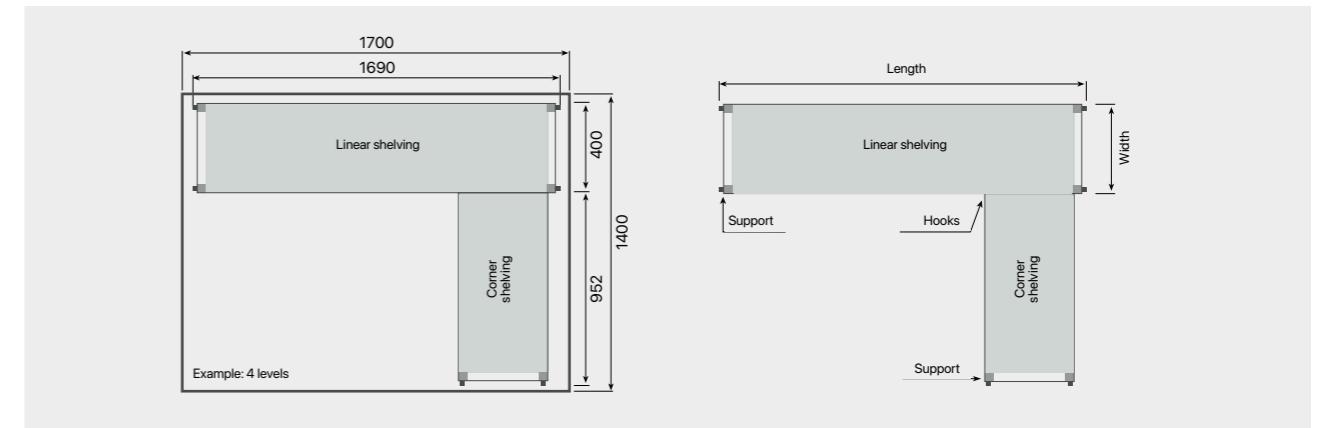

- Standard height of uprights is 1750 mm. For other heights, see the breakdown of the chosen set and replace the "AF17" uprights with "AF20" high uprights, adjusting the price of the set according to the prices of the chosen elements.

- Additional shelving levels can be added, up to a maximum total of 11 levels on standard uprights, by ordering required shelves, pins and corner hooks separately.

- Standard uprights type "AF17" can be replaced by mobile uprights "KMA17", when changing prices.

Linear shelving 400 mm

SHELVING TOTAL LENGTH (mm)	3 LEVELS		4 LEVELS		5 LEVELS	
	SET N°	€	SET N°	€	SET N°	€
1390	17	-	96	-	175	-
1490	18	-	97	-	176	-
1590	19	-	98	-	177	-
1690	20	-	99	-	178	-
1726	21	-	100	-	179	-
1826	22	-	101	-	180	-
1926	23	-	102	-	181	-

Corner shelving 400 mm

SHELVING TOTAL LENGTH (mm)	3 LEVELS		4 LEVELS		5 LEVELS	
	SET N°	€	SET N°	€	SET N°	€
652	500	-	579	-	658	-
752	501	-	580	-	659	-
852	502	-	581	-	660	-
952	503	-	582	-	661	-
1052	504	-	583	-	662	-
1152	505	-	584	-	663	-
1252	506	-	585	-	664	-

Corner shelving 500 mm

3 LEVELS		4 LEVELS		5 LEVELS	
SET N°	SHELVING ITEMS BREAKDOWN	SET N°	SHELVING ITEMS BREAKDOWN	SET N°	SHELVING ITEMS BREAKDOWN
737	1 AF17-53 + 3 SA-56 + 6 HK	816	1 AF17-54 + 4 SA-56 + 8 HK	895	1 AF17-55 + 5 SA-56 + 10 HK
738	1 AF17-53 + 3 SA-57 + 6 HK	817	1 AF17-54 + 4 SA-57 + 8 HK	896	1 AF17-55 + 5 SA-57 + 10 HK
739	1 AF17-53 + 3 SA-58 + 6 HK	818	1 AF17-54 + 4 SA-58 + 8 HK	897	1 AF17-55 + 5 SA-58 + 10 HK
740	1 AF17-53 + 3 SA-59 + 6 HK	819	1 AF17-54 + 4 SA-59 + 8 HK	898	1 AF17-55 + 5 SA-59 + 10 HK
741	1 AF17-53 + 3 SA-510 + 6 HK	820	1 AF17-54 + 4 SA-510 + 8 HK	899	1 AF17-55 + 5 SA-510 + 10 HK
742	1 AF17-53 + 3 SA-511 + 6 HK	821	1 AF17-54 + 4 SA-511 + 8 HK	900	1 AF17-55 + 5 SA-511 + 10 HK
743	1 AF17-53 + 3 SA-512 + 6 HK	822	1 AF17-54 + 4 SA-512 + 8 HK	901	1 AF17-55 + 5 SA-512 + 10 HK
744	1 AF17-53 + 3 SA-513 + 6 HK	823	1 AF17-54 + 4 SA-513 + 8 HK	902	1 AF17-55 + 5 SA-513 + 10 HK
745	1 AF17-53 + 3 SA-514 + 6 HK	824	1 AF17-54 + 4 SA-514 + 8 HK	903	1 AF17-55 + 5 SA-514 + 10 HK
746	1 AF17-53 + 3 SA-515 + 6 HK	825	1 AF17-54 + 4 SA-515 + 8 HK	904	1 AF17-55 + 5 SA-515 + 10 HK
747	1 AF17-53 + 3 SA-516 + 6 HK	826	1 AF17-54 + 4 SA-516 + 8 HK	905	1 AF17-55 + 5 SA-516 + 10 HK
748	2 AF17-53 + 6 SA-58 + 6 HK	827	2 AF17-54 + 8 SA-58 + 8 HK	906	2 AF17-55 + 10 SA-58 + 10 HK
749	2 AF17-53 + 3 SA-59 + 3 SA-58 + 6 HK	828	2 AF17-54 + 4 SA-59 + 4 SA-58 + 8 HK	907	2 AF17-55 + 5 SA-59 + 5 SA-58 + 10 HK
750	2 AF17-53 + 6 SA-59 + 6 HK	829	2 AF17-54 + 8 SA-59 + 8 HK	908	2 AF17-55 + 10 SA-59 + 10 HK
751	2 AF17-53 + 3 SA-59 + 3 SA-510 + 6 HK	830	2 AF17-54 + 4 SA-59 + 4 SA-510 + 8 HK	909	2 AF17-55 + 5 SA-59 + 5 SA-510 + 10 HK
752	2 AF17-53 + 6 SA-510 + 6 HK	831	2 AF17-54 + 8 SA-510 + 8 HK	910	2 AF17-55 + 10 SA-510 + 10 HK
753	2 AF17-53 + 3 SA-510 + 3 SA-511 + 6 HK	832	2 AF17-54 + 4 SA-510 + 4 SA-511 + 8 HK	911	2 AF17-55 + 5 SA-510 + 5 SA-511 + 10 HK
754	2 AF17-53 + 6 SA-511 + 6 HK	833	2 AF17-54 + 8 SA-511 + 8 HK	912	2 AF17-55 + 10 SA-511 + 10 HK
755	2 AF17-53 + 3 SA-511 + 3 SA-512 + 6 HK	834	2 AF17-54 + 4 SA-511 + 4 SA-512 + 8 HK	913	2 AF17-55 + 5 SA-511 + 5 SA-512 + 10 HK
756	2 AF17-53 + 6 SA-512 + 6 HK	835	2 AF17-54 + 8 SA-512 + 8 HK	914	2 AF17-55 + 10 SA-512 + 10 HK
757	2 AF17-53 + 3 SA-512 + 3 SA-513 + 6 HK	836	2 AF17-54 + 4 SA-512 + 4 SA-513 + 8 HK	915	2 AF17-55 + 5 SA-512 + 5 SA-513 + 10 HK
758	2 AF17-53 + 6 SA-513 + 6 HK	837	2 AF17-54 + 8 SA-513 + 8 HK	916	2 AF17-55 + 10 SA-513 + 10 HK
759	2 AF17-53 + 3 SA-513 + 3 SA-514 + 6 HK	838	2 AF17-54 + 4 SA-513 + 4 SA-514 + 8 HK	917	2 AF17-55 + 5 SA-513 + 5 SA-514 + 10 HK
760	2 AF17-53 + 6 SA-514 + 6 HK	839	2 AF17-54 + 8 SA-514 + 8 HK	918	2 AF17-55 + 10 SA-514 + 10 HK
761	2 AF17-53 + 3 SA-514 + 3 SA-515 + 6 HK	840	2 AF17-54 + 4 SA-514 + 4 SA-515 + 8 HK	919	2 AF17-55 + 5 SA-514 + 5 SA-515 + 10 HK
762	2 AF17-53 + 6 SA-515 + 6 HK	841	2 AF17-54 + 8 SA-515 + 8 HK	920	2 AF17-55 + 10 SA-515 + 10 HK
763	2 AF17-53 + 3 SA-515 + 3 SA-516 + 6 HK	842	2 AF17-54 + 4 SA-515 + 4 SA-516 + 8 HK	921	2 AF17-55 + 5 SA-515 + 5 SA-516 + 10 HK
764	2 AF17-53 + 6 SA-516 + 6 HK	843	2 AF17-54 + 8 SA-516 + 8 HK	922	2 AF17-55 + 10 SA-516 + 10 HK
765	3 AF17-53 + 3 SA-510 + 6 SA-511 + 6 HK	844	3 AF17-54 + 4 SA-510 + 8 SA-511 + 8 HK	923	3 AF17-55 + 5 SA-510 + 10 SA-511 + 10 HK
766	3 AF17-53 + 9 SA-511 + 6 HK	845	3 AF17-54 + 12 SA-511 + 8 HK	924	3 AF17-55 + 15 SA-511 + 10 HK
767	3 AF17-53 + 6 SA-511 + 3 SA-512 + 6 HK	846	3 AF17-54 + 8 SA-511 + 4 SA-512 + 8 HK	925	3 AF17-55 + 10 SA-511 + 5 SA-512 + 10 HK
768	3 AF17-53 + 3 SA-511 + 6 SA-512 + 6 HK	847	3 AF17-54 + 4 SA-511 + 6 SA-512 + 8 HK	926	3 AF17-55 + 5 SA-511 + 10 SA-512 + 10 HK
769	3 AF17-53 + 9 SA-512 + 6 HK	848	3 AF17-54 + 12 SA-512 + 8 HK	927	3 AF17-55 + 15 SA-512 + 10 HK
770	3 AF17-53 + 6 SA-512 + 3 SA-513 + 6 HK	849	3 AF17-54 + 8 SA-512 + 4 SA-513 + 8 HK	928	3 AF17-55 + 10 SA-512 + 5 SA-513 + 10 HK
771	3 AF17-53 + 3 SA-512 + 6 SA-513 + 6 HK	850	3 AF17-54 + 4 SA-512 + 8 SA-513 + 8 HK	929	3 AF17-55 + 5 SA-512 + 10 SA-513 + 10 HK
772	3 AF17-53 + 9 SA-513 + 6 HK	851	3 AF17-54 + 12 SA-513 + 8 HK	930	3 AF17-55 + 15 SA-513 + 10 HK
773	3 AF17-53 + 6 SA-513 + 3 SA-514 + 6 HK	852	3 AF17-54 + 8 SA-513 + 4 SA-514 + 8 HK	931	3 AF17-55 + 10 SA-513 + 5 SA-514 + 10 HK
774	3 AF17-53 + 3 SA-513 + 6 SA-514 + 6 HK	853	3 AF17-54 + 4 SA-513 + 8 SA-514 + 8 HK	932	3 AF17-55 + 5 SA-513 + 10 SA-514 + 10 HK
775	3 AF17-53 + 9 SA-514 + 6 HK	854	3 AF17-54 + 12 SA-514 + 8 HK	933	3 AF17-55 + 15 SA-514 + 10 HK
776	3 AF17-53 + 6 SA-514 + 3 SA-515 + 6 HK	855	3 AF17-54 + 8 SA-514 + 4 SA-515 + 8 HK	934	3 AF17-55 + 10 SA-514 + 5 SA-515 + 10 HK
777	3 AF17-53 + 3 SA-514 + 6 SA-515 + 6 HK	856	3 AF17-54 + 4 SA-514 + 8 SA-515 + 8 HK	935	3 AF17-55 + 5 SA-514 + 10 SA-515 + 10 HK
778	3 AF17-53 + 9 SA-515 + 6 HK	857	3 AF17-54 + 12 SA-515 + 8 HK	936	3 AF17-55 + 15 SA-515 + 10 HK
779	3 AF17-53 + 6 SA-515 + 3 SA-516 + 6 HK	858	3 AF17-54 + 8 SA-515 + 4 SA-516 + 8 HK	937	3 AF17-55 + 10 SA-515 + 5 SA-516 + 10 HK
780	3 AF17-53 + 3 SA-515 + 6 SA-516 + 6 HK	859	3 AF17-54 + 4 SA-515 + 8 SA-516 + 8 HK	938	3 AF17-55 + 5 SA-515 + 10 SA-516 + 10 HK
781	3 AF17-53 + 9 SA-516 + 6 HK	860	3 AF17-54 + 12 SA-516 + 8 HK	939	3 AF17-55 + 15 SA-516 + 10 HK
782	4 AF17-53 + 12 SA-512 + 6 HK	861	4 AF17-54 + 16 SA-512 + 8 HK	940	4 AF17-55 + 20 SA-512 + 10 HK
783	4 AF17-53 + 9 SA-512 + 3 SA-513 + 6 HK	862	4 AF17-54 + 12 SA-512 + 4 SA-513 + 8 HK	941	4 AF17-55 + 15 SA-512 + 5 SA-513 + 10 HK
784	4 AF17-53 + 6 SA-512 + 6 SA-513 + 6 HK	863	4 AF17-54 + 8 SA-512 + 8 SA-513 + 8 HK	942	4 AF17-55 + 10 SA-512 + 10 SA-513 + 10 HK
785	4 AF17-53 + 3 SA-512 + 9 SA-513 + 6 HK	864	4 AF17-54 + 4 SA-512 + 12 SA-513 + 8 HK	943	4 AF17-55 + 5 SA-512 + 15 SA-513 + 10 HK
786	4 AF17-53 + 12 SA-513 + 6 HK	865	4 AF17-54 + 16 SA-513 + 8 HK	944	4 AF17-55 + 20 SA-513 + 10 HK
787	4 AF17-53 + 9 SA-513 + 3 SA-514 + 6 HK	866	4 AF17-54 + 12 SA-513 + 4 SA-514 + 8 HK	945	4 AF17-55 + 15 SA-513 + 5 SA-514 + 10 HK
788	4 AF17-53 + 6 SA-513 + 6 SA-514 + 6 HK	867	4 AF17-54 + 8 SA-513 + 8 SA-514 + 8 HK	946	4 AF17-55 + 10 SA-513 + 10 SA-514 + 10 HK
789	4 AF17-53 + 3 SA-513 + 9 SA-514 + 6 HK	868	4 AF17-54 + 4 SA-513 + 12 SA-514 + 8 HK	947	4 AF17-55 + 5 SA-513 + 15 SA-514 + 10 HK
790	4 AF17-53 + 12 SA-514 + 6 HK	869	4 AF17-54 + 16 SA-514 + 8 HK	948	4 AF17-55 + 20 SA-514 + 10 HK

Corner shelving 600 mm

3 LEVELS		4 LEVELS		5 LEVELS	
SET N°	SHELVING ITEMS BREAKDOWN	SET N°	SHELVING ITEMS BREAKDOWN	SET N°	SHELVING ITEMS BREAKDOWN
1500	1 AF17-63 + 3 SA-66 + 6 HK	1579	1 AF17-64 + 4 SA-66 + 8 HK	1658	1 AF17-65 + 5 SA-66 + 10 HK
1501	1 AF17-63 + 3 SA-67 + 6 HK	1580	1 AF17-64 + 4 SA-67 + 8 HK	1659	1 AF17-65 + 5 SA-67 + 10 HK
1502	1 AF17-63 + 3 SA-68 + 6 HK	1581	1 AF17-64 + 4 SA-68 + 8 HK	1660	1 AF17-65 + 5 SA-68 + 10 HK
1503	1 AF17-63 + 3 SA-69 + 6 HK	1582	1 AF17-64 + 4 SA-69 + 8 HK	1661	1 AF17-65 + 5 SA-69 + 10 HK
1504	1 AF17-63 + 3 SA-610 + 6 HK	1583	1 AF17-64 + 4 SA-610 + 8 HK	1662	1 AF17-65 + 5 SA-610 + 10 HK
1505	1 AF17-63 + 3 SA-611 + 6 HK	1584	1 AF17-64 + 4 SA-611 + 8 HK	1663	1 AF17-65 + 5 SA-611 + 10 HK
1506	1 AF17-63 + 3 SA-612 + 6 HK	1585	1 AF17-64 + 4 SA-612 + 8 HK	1664	1 AF17-65 + 5 SA-612 + 10 HK
1507	1 AF17-63 + 3 SA-613 + 6 HK	1586	1 AF17-64 + 4 SA-613 + 8 HK	1665	1 AF17-65 + 5 SA-613 + 10 HK
1508	1 AF17-63 + 3 SA-614 + 6 HK	1587	1 AF17-64 + 4 SA-614 + 8 HK	1666	1 AF17-65 + 5 SA-614 + 10 HK
1509	1 AF17-63 + 3 SA-615 + 6 HK	1588	1 AF17-64 + 4 SA-615 + 8 HK	1667	1 AF17-65 + 5 SA-615 + 10 HK
1510	1 AF17-63 + 3 SA-616 + 6 HK	1589	1 AF17-64 + 4 SA-616 + 8 HK	1668	1 AF17-65 + 5 SA-616 + 10 HK
1511	2 AF17-63 + 6 SA-68 + 6 HK	1590	2 AF17-64 + 8 SA-68 + 8 HK	1669	2 AF17-65 + 10 SA-68 + 10 HK
1512	2 AF17-63 + 3 SA-69 + 3 SA-68 + 6 HK	1591	2 AF17-64 + 4 SA-69 + 4 SA-68 + 8 HK	1670	2 AF17-65 + 5 SA-69 + 5 SA-68 + 10 HK
1513	2 AF17-63 + 6 SA-69 + 6 HK	1592	2 AF17-64 + 8 SA-69 + 8 HK	1671	2 AF17-65 + 10 SA-69 + 10 HK
1514	2 AF17-63 + 3 SA-69 + 3 SA-610 + 6 HK	1593	2 AF17-64 + 4 SA-69 + 4 SA-610 + 8 HK	1672	2 AF17-65 + 5 SA-69 + 5 SA-610 + 10 HK
1515	2 AF17-63 + 6 SA-610 + 6 HK	1594	2 AF17-64 + 8 SA-610 + 8 HK	1673	2 AF17-65 + 10 SA-610 + 10 HK
1516	2 AF17-63 + 3 SA-610 + 3 SA-611 + 6 HK	1595	2 AF17-64 + 4 SA-610 + 4 SA-611 + 8 HK	1674	2 AF17-65 + 5 SA-610 + 5 SA-611 + 10 HK
1517	2 AF17-63 + 6 SA-611 + 6 HK	1596	2 AF17-64 + 8 SA-611 + 8 HK	1675	2 AF17-65 + 10 SA-611 + 10 HK
1518	2 AF17-63 + 3 SA-611 + 3 SA-612 + 6 HK	1597	2 AF17-64 + 4 SA-611 + 4 SA-612 + 8 HK	1676	2 AF17-65 + 5 SA-611 + 5 SA-612 + 10 HK
1519	2 AF17-63 + 6 SA-612 + 6 HK	1598	2 AF17-64 + 8 SA-612 + 8 HK	1677	2 AF17-65 + 10 SA-612 + 10 HK
1520	2 AF17-63 + 3 SA-612 + 3 SA-613 + 6 HK	1599	2 AF17-64 + 4 SA-612 + 4 SA-613 + 8 HK	1678	2 AF17-65 + 5 SA-612 + 5 SA-613 + 10 HK
1521	2 AF17-63 + 6 SA-613 + 6 HK	1600	2 AF17-64 + 8 SA-613 + 8 HK	1679	2 AF17-65 + 10 SA-613 + 10 HK
1522	2 AF17-63 + 3 SA-613 + 3 SA-614 + 6 HK	1601	2 AF17-64 + 4 SA-613 + 4 SA-614 + 8 HK	1680	2 AF17-65 + 5 SA-613 + 5 SA-614 + 10 HK
1523	2 AF17-63 + 6 SA-614 + 6 HK	1602	2 AF17-64 + 8 SA-614 + 8 HK	1681	2 AF17-65 + 10 SA-614 + 10 HK
1524	2 AF17-63 + 3 SA-614 + 3 SA-615 + 6 HK	1603	2 AF17-64 + 4 SA-614 + 4 SA-615 + 8 HK	1682	2 AF17-65 + 5 SA-614 + 5 SA-615 + 10 HK
1525	2 AF17-63 + 6 SA-615 + 6 HK	1604	2 AF17-64 + 8 SA-615 + 8 HK	1683	2 AF17-65 + 10 SA-615 + 10 HK
1526	2 AF17-63 + 3 SA-615 + 3 SA-616 + 6 HK	1605	2 AF17-64 + 4 SA-615 + 4 SA-616 + 8 HK	1684	2 AF17-65 + 5 SA-615 + 5 SA-616 + 10 HK
1527	2 AF17-63 + 6 SA-616 + 6 HK	1606	2 AF17-64 + 8 SA-616 + 8 HK	1685	2 AF17-65 + 10 SA-616 + 10 HK
1528	3 AF17-63 + 3 SA-610 + 6 SA-611 + 6 HK	1607	3 AF17-64 + 4 SA-610 + 8 SA-611 + 8 HK	1686	3 AF17-65 + 5 SA-610 + 10 SA-611 + 10 HK
1529	3 AF17-63 + 9 SA-611 + 6 HK	1608	3 AF17-64 + 12 SA-611 + 8 HK	1687	3 AF17-65 + 15 SA-611 + 10 HK
1530	3 AF17-63 + 6 SA-611 + 3 SA-612 + 6 HK	1609	3 AF17-64 + 8 SA-611 + 4 SA-612 + 8 HK	1688	3 AF17-65 + 10 SA-611 + 5 SA-612 + 10 HK
1531	3 AF17-63 + 3 SA-611 + 6 SA-612 + 6 HK	1610	3 AF17-64 + 4 SA-611 + 6 SA-612 + 8 HK	1689	3 AF17-65 + 5 SA-611 + 10 SA-612 + 10 HK
1532	3 AF17-63 + 9 SA-612 + 6 HK	1611	3 AF17-64 + 12 SA-612 + 8 HK	1690	3 AF17-65 + 15 SA-612 + 10 HK
1533	3 AF17-63 + 6 SA-612 + 3 SA-613 + 6 HK	1612	3 AF17-64 + 8 SA-612 + 4 SA-613 + 8 HK	1691	3 AF17-65 + 10 SA-612 + 5 SA-613 + 10 HK
1534	3 AF17-63 + 3 SA-612 + 6 SA-613 + 6 HK	1613	3 AF17-64 + 4 SA-612 + 8 SA-613 + 8 HK	1692	3 AF17-65 + 5 SA-612 + 10 SA-613 + 10 HK
1535	3 AF17-63 + 9 SA-613 + 6 HK	1614	3 AF17-64 + 12 SA-613 + 8 HK	1693	3 AF17-65 + 15 SA-613 + 10 HK
1536	3 AF17-63 + 6 SA-613 + 3 SA-614 + 6 HK	1615	3 AF17-64 + 8 SA-613 + 4 SA-614 + 8 HK	1694	3 AF17-65 + 10 SA-613 + 5 SA-614 + 10 HK
1537	3 AF17-63 + 3 SA-613 + 6 SA-614 + 6 HK	1616	3 AF17-64 + 4 SA-613 + 8 SA-614 + 8 HK	1695	3 AF17-65 + 5 SA-613 + 10 SA-614 + 10 HK
1538	3 AF17-63 + 9 SA-614 + 6 HK	1617	3 AF17-64 + 12 SA-614 + 8 HK	1696	3 AF17-65 + 15 SA-614 + 10 HK
1539	3 AF17-63 + 6 SA-614 + 3 SA-615 + 6 HK	1618	3 AF17-64 + 8 SA-614 + 4 SA-615 + 8 HK	1697	3 AF17-65 + 10 SA-614 + 5 SA-615 + 10 HK
1540	3 AF17-63 + 3 SA-614 + 6 SA-615 + 6 HK	1619	3 AF17-64 + 4 SA-614 + 8 SA-615 + 8 HK	1698	3 AF17-65 + 5 SA-614 + 10 SA-615 + 10 HK
1541	3 AF17-63 + 9 SA-615 + 6 HK	1620	3 AF17-64 + 12 SA-615 + 8 HK	1699	3 AF17-65 + 15 SA-615 + 10 HK
1542	3 AF17-63 + 6 SA-615 + 3 SA-616 + 6 HK	1621	3 AF17-64 + 8 SA-615 + 4 SA-616 + 8 HK	1700	3 AF17-65 + 10 SA-615 + 5 SA-616 + 10 HK
1543	3 AF17-63 + 3 SA-615 + 6 SA-616 + 6 HK	1622	3 AF17-64 + 4 SA-615 + 8 SA-616 + 8 HK	1701	3 AF17-65 + 5 SA-615 + 10 SA-616 + 10 HK
1544	3 AF17-63 + 9 SA-616 + 6 HK	1623	3 AF17-64 + 12 SA-616 + 8 HK	1702	3 AF17-65 + 15 SA-616 + 10 HK
1545	4 AF17-63 + 12 SA-612 + 6 HK	1624	4 AF17-64 + 16 SA-612 + 8 HK	1703	4 AF17-65 + 20 SA-612 + 10 HK
1546	4 AF17-63 + 9 SA-612 + 3 SA-613 + 6 HK	1625	4 AF17-64 + 12 SA-612 + 4 SA-613 + 8 HK	1704	4 AF17-65 + 15 SA-612 + 5 SA-613 + 10 HK
1547	4 AF17-63 + 6 SA-612 + 6 SA-613 + 6 HK	1626	4 AF17-64 + 8 SA-612 + 8 SA-613 + 8 HK	1705	4 AF17-65 + 10 SA-612 + 10 SA-613 + 10 HK
1548	4 AF17-63 + 3 SA-612 + 9 SA-613 + 6 HK	1627	4 AF17-64 + 4 SA-612 + 12 SA-613 + 8 HK	1706	4 AF17-65 + 5 SA-612 + 15 SA-613 + 10 HK
1549	4 AF17-63 + 12 SA-613 + 6 HK	1628	4 AF17		

